

Piezoelectric Ceramic Products

FUNDAMENTALS, CHARACTERISTICS AND APPLICATIONS



Contents

PI Ceramic – Leaders in Piezoelectric Technology	3
Product Overview	6
Fundamentals of Piezo Technology	
Piezoelectric Effect and Piezo Technology	8
Electromechanics	10
Dynamic Behavior	12
Piezo Ceramics – Materials, Components, Products	
Material Properties and Classification	14
Soft and Hard Piezo Ceramics	14
Lead-Free Materials	15
Overview	16
Material Data	18
Temperature Dependence of the Coefficients	20
Manufacturing Technology	
Pressing Technology	22
Co-firing, Tape Technology, Multilayer	23
Flexibility in Shape and Design	24
PICMA [®] Multilayer Actuators with Long Lifetime	25
Metallization and Assembling Technology	26
Piezo Ceramic Components: Dimensions	27
Testing Procedures	30
Integrated Components, Sub-Assemblies	31
Applications	
Application Examples for Piezoceramic Elements	32
Pumping and Dosing Techniques with Piezo Drives	33
Ultrasound Applications in Medical Engineering	34
Ultrasonic Sensors	35
Piezoelectric Actuators	37
Vibration Control	39
Adaptronics	40
Energy from Vibration – Energy Harvesting	40
Ultrasonic Machining of Materials	41
Sonar Technology and Hydroacoustics	41
PI Milestones	42

Imprint

PI Ceramic GmbH, Lindenstrasse, 07589 Lederhose, Germany
 Registration: HRB 203 582, Jena local court
 VAT no.: DE 155932487
 Executive board: Albrecht Otto, Dr. Peter Schittenhelm, Dr. Karl Spanner
 Phone +49 36604 -882-0, Fax +49-36604-882-4109
 info@piceramic.com, www.piceramic.com

Although the information in this document has been compiled with the greatest care, errors cannot be ruled out completely. Therefore, we cannot guarantee for the information being complete, correct and up to date. Illustrations may differ from the original and are not binding. PI reserves the right to supplement or change the information provided without prior notice. All contents, including texts, graphics, data etc., as well as their layout, are subject to copyright and other protective laws. Any copying, modification or redistribution in whole or in parts is subject to a written permission of PI. The following company names and brands are registered trademarks of Physik Instrumente (PI) GmbH & Co. KG: PI[®], PIC[®], NanoCube[®], PICMA[®], PILine[®], NEXLINE[®], PiezoWalk[®], NEXACT[®], Picoactuator[®], PInano[®], PIMag[®]. The following company names or brands are the registered trademarks of their owners: µManager, LabVIEW, Leica, Linux, MATLAB, MetaMorph, Microsoft, National Instruments, Nikon, Olympus, Windows, Zeiss.

PI Ceramic

LEADERS IN PIEZOELECTRIC TECHNOLOGY

PI Ceramic is one of the world's market leaders for piezoelectric actuators and sensors. PI Ceramic provides everything related to piezo ceramics, from the material and components right through to the complete integration. PI Ceramic provides system solutions for research and industry in all high-tech markets including medical engineering, mechanical engineering and automobile manufacture, or semiconductor technology.

Materials Research and Development

PI Ceramic develops all its piezoceramic materials itself. To this end PI Ceramic maintains its own laboratories, prototype manufacture as well as measurement and testing stations. Moreover, PI Ceramic works with leading universities and research institutions at home and abroad in the field of piezoelectricity.

Flexible Production

In addition to the broad spectrum of standard products, the fastest possible realization of customer-specific requirements is a top priority. Our pressing and multilayer technology enables us to shape products with a short lead time. We are able to manufacture individual prototypes as well as high-volume production runs. All processing steps are undertaken in-house and are subject to continuous controls, a process which ensures quality and adherence to deadlines.



Certified Quality

Since 1997, PI Ceramic has been certified according to the ISO 9001 standard, where the emphasis is not only on product quality but primarily on the expectations of the customer and his satisfaction. PI Ceramic is also certified according to the ISO 14001 (environmental management) and OHSAS 18001 (occupational safety) standards, which taken together, form an Integrated Management System (IMS). PI Ceramic is a subsidiary of Physik Instrumente (PI) and develops and produces all piezo actuators for PI's nanopositioning systems. The drives for PILine[®] ultrasonic piezomotors and NEXLINE[®] high-load stepping drives also originate from PI Ceramic.

Core Competences of PI Ceramic

- Standard piezo components for actuators, ultrasonic and sensor applications
- System solutions
- Manufacturing of piezoelectric components of up to several million units per year
- Development of custom-engineered solutions
- High degree of flexibility in the engineering process, short lead times, manufacture of individual units and very small quantities
- All key technologies and state-of-the-art equipment for ceramic production in-house
- Certified in accordance with ISO 9001, ISO 14001 and OHSAS 18001

Company building of PI Ceramic in Lederhose, Thuringia, Germany



Reliability and Close Contact with our Customers

OUR MISSION



PI Ceramic provides

- Piezoceramic materials (PZT)
- Piezoceramic components
- Customized and application-specific ultrasonic transducers/transducers
- PICMA[®] monolithic multilayer piezo actuators
- Miniature piezo actuators
- PICMA[®] multilayer bender actuators
- PICA high-load piezo actuator
- PT Tube piezo actuators
- Preloaded actuators with casing
- Piezocomposites – DuraAct patch transducers

Our aim is to maintain high, tested quality for both our standard products and for custom-engineered components. We want you, our customers, to be satisfied with the performance of our products. At PI Ceramic, customer service starts with an initial informative discussion and extends far beyond the shipping of the products.

Advice from Piezo Specialists

You want to solve complex problems – we won't leave you to your own devices. We use our years of experience in planning, developing, designing and the production of individual solutions to accompany you from the initial idea to the finished product. We take the time necessary for a detailed understanding of the issues and work out a comprehensive and optimum solution at an early stage with either existing or new technologies.

After-Sales Service

Even after the sale has been completed, our specialists are available to you and can advise you on system upgrades or technical issues. This is how we at PI Ceramic achieve our objective: Long-lasting business relations and a trusting communication with customers and suppliers, both of which are more important than any short-term success.

PI Ceramic supplies piezo-ceramic solutions to all important high-tech markets:

- Industrial automation
- Semiconductor industry
- Medical engineering
- Mechanical and precision engineering
- Aviation and aerospace
- Automotive industry
- Telecommunications

Experience and Know-How

STATE-OF-THE-ART MANUFACTURING TECHNOLOGY

Developing and manufacturing piezoceramic components are very complex processes. PI Ceramic has many years of experience in this field and has developed sophisticated manufacturing methods. Its machines and equipment are state of the art.

Rapid Prototyping

The requirements are realized quickly and flexibly in close liaison with the customer. Prototypes and small production runs of custom-engineered piezo components are available after very short processing times. The manufacturing conditions, i.e. the composition of the material or the sintering temperature, for example, are individually adjusted to the ceramic material in order to achieve optimum material parameters.

Precision Machining Technology

PI Ceramic uses machining techniques from the semiconductor industry to machine the sensitive piezoceramic elements with a

particularly high degree of precision. Special milling machines accurately shape the components when they are still in the "green state", i.e. before they are sintered. Sintered ceramic blocks are machined with precision saws like the ones used to separate individual wafers. Very fine holes, structured ceramic surfaces, even complex, three-dimensional contours can be produced.

Automated Series Production – Advantage for OEM Customers

An industrial application often requires large quantities of custom-engineered components. At PI Ceramic, the transition to large production runs can be achieved in a reliable and low-cost way while maintaining the high quality of the products. PI Ceramic has the capacity to produce and process medium-sized and large production runs in linked automated lines. Automatic screen printers and the latest PVD units are used to metallize the ceramic parts.



Automated processes optimize throughput

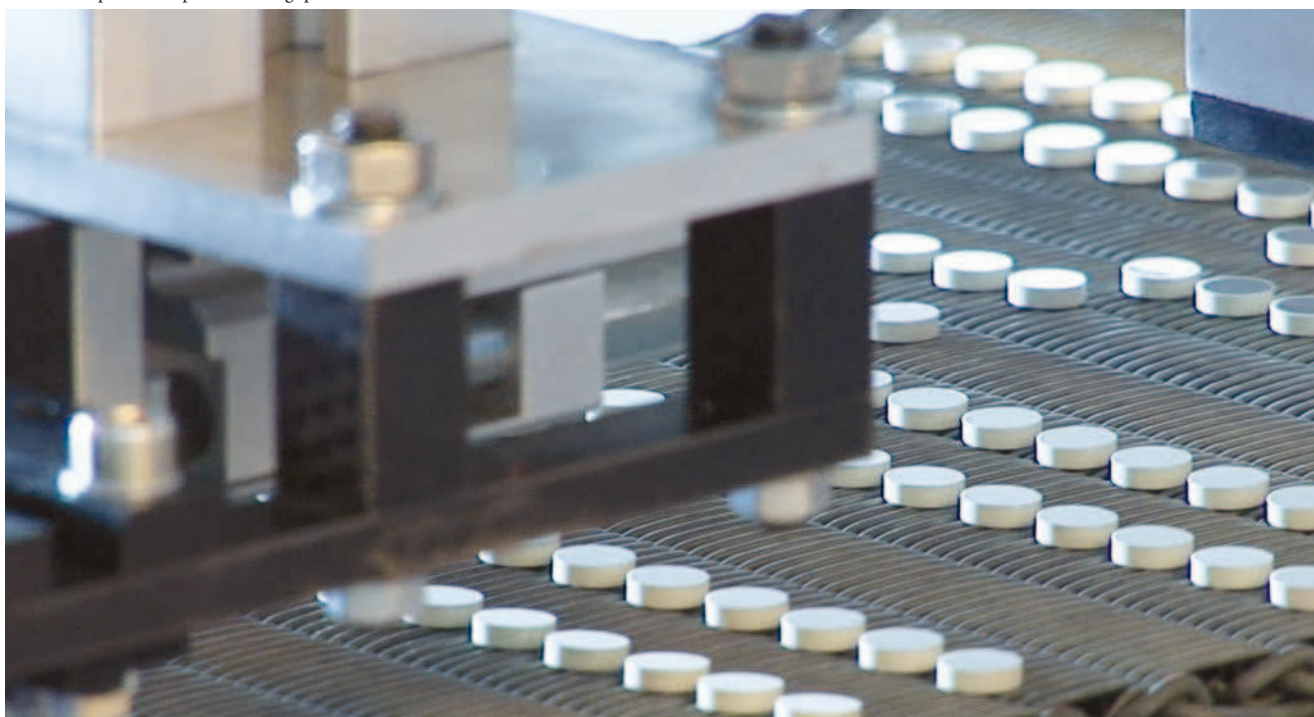

Product Overview

IN-HOUSE DEVELOPMENT AND PRODUCTION



Piezoelectric Components

- Various different versions in many different geometries such as disks, plates, tubes, customized shapes
- High resonant frequencies to 20 MHz

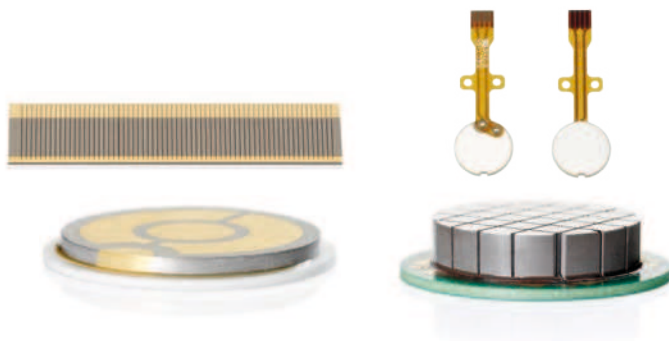

OEM Adaptations

- Piezo transducers for ultrasonic applications
- Assembly of complete transducer components
- 2D or line arrays

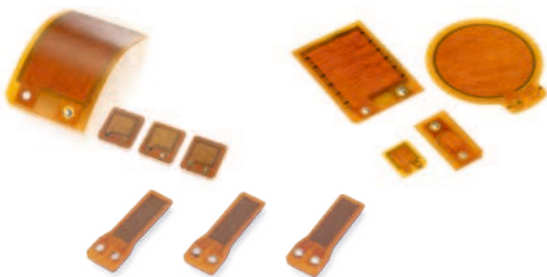

DuraAct Piezo Patch Transducers

- Actuator or sensor, structural health monitoring
- Bendable and robust, preloaded due to lamination

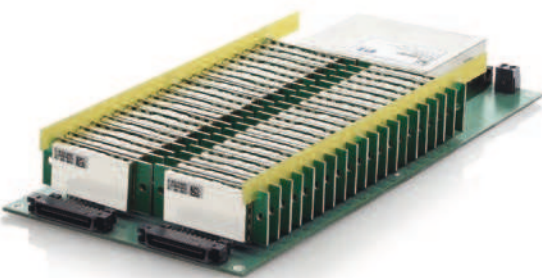

Control Electronics

- Different performance classes
- OEM modules and benchtop devices

PICMA® Multilayer Piezo Actuators

- Low piezo voltage to 120 V
- High stiffness
- Travel ranges to 100 μm



PICA High-Load Actuators

- Travel ranges to 300 μm
- Forces to 100 kN



PICMA® Multilayer Bending Actuators

- Bidirectional displacement to 2 mm
- Low operating voltage to 60 V
- Contractors, variable contours

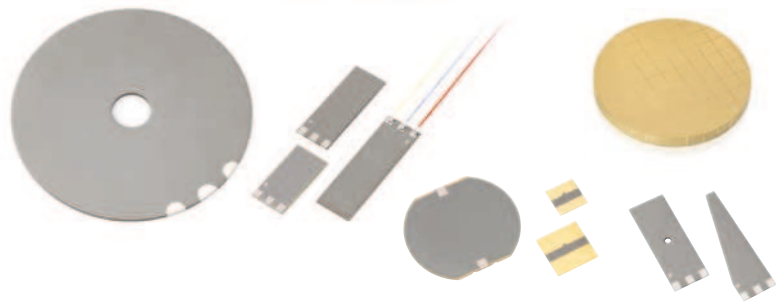

Piezo Actuators with Customized Equipment

- For use in a harsh environment
- Position and temperature monitoring
- For cryogenic temperatures

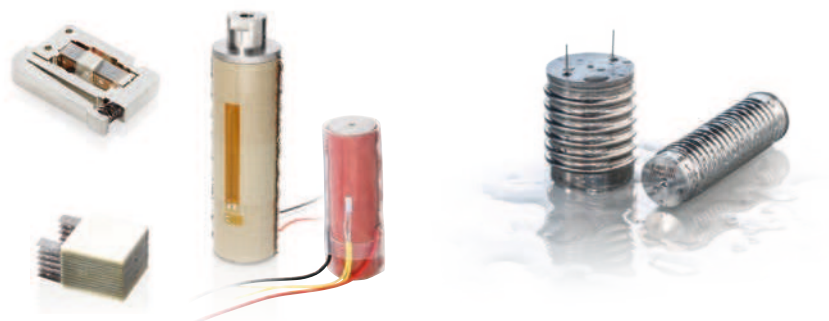

Piezoelectric Effect and Piezo Technology

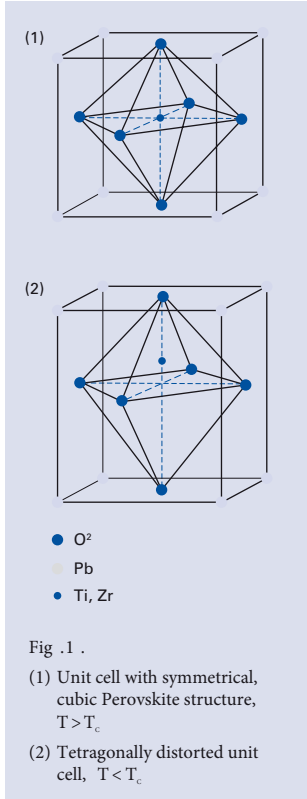

Piezoelectric materials convert electrical energy into mechanical energy and vice versa . The piezoelectric effect is now used in many everyday products such as lighters, loudspeakers and signal transducers .Piezo actuator technology has also gained acceptance in automotive technology, because piezo-controlled injection valves in combustion engines reduce the transition times and significantly improve the smoothness and exhaust gas quality .

From the Physical Effect to Industrial Use

The word “piezo“ is derived from the Greek word for pressure .In 1880 Jacques and Pierre Curie discovered that pressure generates electrical charges in a number of crystals such as Quartz and Tourmaline; they called this phenomenon the “piezoelectric effect“ . Later they noticed that electrical fields can deform piezoelectric materials .This effect is called the “inverse piezoelectric effect“ .The industrial breakthrough came with piezoelectric ceramics, when scientists discovered that Barium Titanate assumes piezoelectric characteristics on a useful scale when an electric field is applied .

Piezoelectric Ceramics ...

The piezoelectric effect of natural monocrystalline materials such as Quartz, Tourmaline and Seignette salt is relatively small . Polycrystalline ferroelectric ceramics such as Barium Titanate ($BaTiO_3$) and Lead Zirconate Titanate (PZT) exhibit larger displacements or induce larger electric voltages .PZT piezo ceramic materials are available in many modifications and are most widely used for actuator or sensor applications .Special dopings of the PZT ceramics with e.g. Ni, Bi, Sb, Nb ions make it possible to specifically optimize piezoelectric and dielectric parameters .

... with Polycrystalline Structure

At temperatures below the Curie temperature, the lattice structure of the PZT crystallites becomes deformed and asymmetric . This brings about the formation of dipoles and the rhombohedral and tetragonal crystallite phases which are of interest for piezotechnology .The ceramic exhibits spontaneous polarization (see Fig .1).Above the Curie temperature the piezoceramic material loses its piezoelectric properties .

Direct Piezoelectric Effect

Mechanical stresses arising as the result of an external force that act on the piezoelectric body induce displacements of the electrical dipoles .This generates an electric field, which produces a corresponding electric voltage .This direct piezoelectric effect is also called the sensor or generator effect .

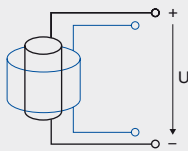

Inverse Piezoelectric Effect

When an electric voltage is applied to an unrestrained piezoceramic component it

brings about a geometric deformation .The movement achieved is a function of the polarity, of the voltage applied and the direction of the polarization in the device . The application of an AC voltage produces an oscillation, i.e. a periodic change of the geometry, for example the increase or reduction of the diameter of a disk .If the body is clamped, i.e. free deformation is constrained, a mechanical stress or force is generated .This effect is frequently also called the actuator or motor effect .

Ferroelectric Domain Structure

One effect of the spontaneous polarization is that the discrete PZT crystallites become piezoelectric. Groups of unit cells with the same orientation are called ferroelectric domains. Because of the random distribution of the domain orientations in the ceramic material no macroscopic piezoelectric behavior is observable. Due to the ferroelectric nature of the material, it is possible to force permanent reorientation and alignment of the different domains using a strong electric field. This process is called poling (see Fig. 2).

Polarization of the Piezoceramics

The poling process results in a remnant polarization P_r , which coincides with a remnant expansion of the material and

which is degraded again when the mechanical, thermal and electrical limit values of the material are exceeded (see Fig. 3). The ceramic now exhibits piezoelectric properties and will change dimensions when an electric voltage is applied. Some PZT ceramics must be poled at an elevated temperature.

When the permissible operating temperature is exceeded, the polarized ceramic depolarizes. The degree of depolarization is depending on the Curie temperature of the material.

An electric field of sufficient strength can reverse the polarization direction (see Fig. 4). The link between mechanical and electrical parameters is of crucial significance for the widespread technical utilization of piezoceramics.

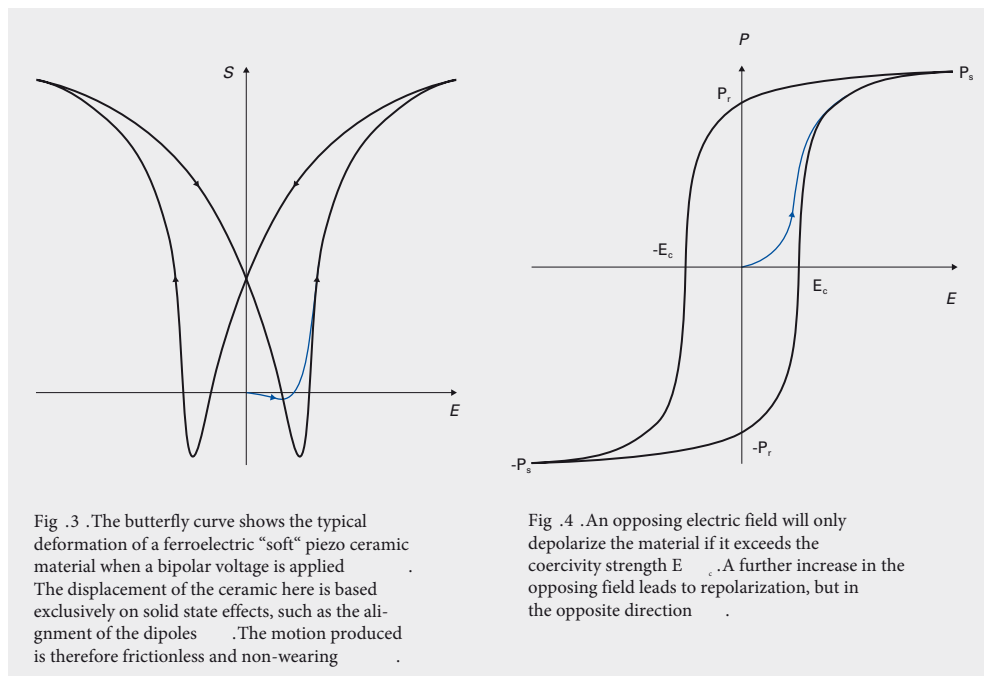
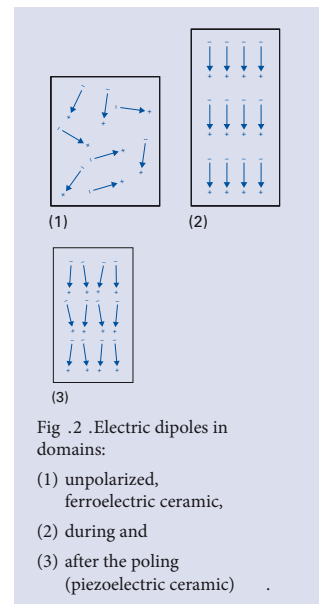

Electromechanics

FUNDAMENTAL EQUATIONS AND PIEZOELECTRIC COEFFICIENTS

- D electric flux density, or dielectric displacement
- T mechanical stress
- E electric field
- S mechanical strain
- d piezoelectric charge coefficient
- ϵ^T dielectric permittivity (for $T = \text{constant}$)
- s^E elastic coefficient (for $E = \text{constant}$)

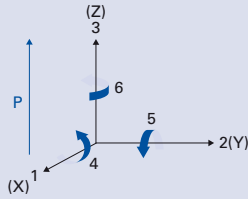

Fig .5 .Orthogonal coordinate system to describe the properties of a poled piezoelectric ceramic .The polarization vector is parallel to the 3 (Z)-axis .

Polarized piezoelectric materials are characterized by several coefficients and relationships . In simplified form, the basic relationships between the electrical and elastic properties can be represented as follows :

$$D = dT + \epsilon^T E$$

$$S = s^E T + dE$$

These relationships apply only to small electrical and mechanical amplitudes, so-called small signal values . Within this range the relationships between the elastic deformation (S) or stress (T) components and the components of the electric field E or the electric flux density D are linear .

Assignment of Axis

The directions are designated by 1, 2, and 3, corresponding to axes X, Y and Z of the classical right-hand orthogonal axis set . The rotational axes are designated with 4, 5 and 6 (see Fig .5) . The direction of polarization (axis 3) is established during the poling process by a strong electrical field applied between the two electrodes . Since the piezoelectric material is anisotropic, the corresponding physical quantities are described by tensors . The piezoelectric coefficients are therefore indexed accordingly .

Permittivity ϵ

The relative permittivity, or relative dielectric coefficient, ϵ is the ratio of the absolute permittivity of the ceramic material and the permittivity in vacuum ($\epsilon_0 = 8.85 \times 10^{-12}$ F/m), where the absolute permittivity is a measure of the polarizability . The dependency of the permittivity from the orientation of the electric field and the flux density is described by indexes .

Examples

ϵ_{33}^T permittivity value in the polarization direction when an electric field is applied parallel to the direction of the polarity (direction 3), under conditions of constant mechanical stress ($T = 0$: "free" permittivity) .

ϵ_{11}^S permittivity if the electric field and dielectric displacement are in direction 1 at constant deformation ($S = 0$: "clamped" permittivity) .

Piezoelectric Charge or Strain Coefficient, Piezo Modulus d_i

The piezo modulus is the ratio of induced electric charge to mechanical stress or of achievable mechanical strain to electric field applied ($T = \text{constant}$) .

Example

d_{33} mechanical strain induced per unit of electric field applied in V/m or charge density in C/m² per unit pressure in N/m², both in polarization direction .

Piezoelectric Voltage Coefficient g_{ij}

The piezoelectric voltage coefficient g is the ratio of electric field E to the effective mechanical stress T . Dividing the respective piezoelectric charge coefficient d_{ij} by the corresponding permittivity gives the corresponding g_{ij} coefficient .

Example

g_{31} describes the electric field induced in direction 3 per unit of mechanical stress acting in direction 1 . Stress = force per unit area, not necessarily orthogonal .

Elastic Compliance s_{ij}

The elastic compliance coefficient s is the ratio of the relative deformation S to the mechanical stress T . Mechanical and electrical energy are mutually dependent, the electrical boundary conditions such as the electric flux density D and field E must therefore be taken into consideration.

Examples

s_{33}^E the ratio of the mechanical strain in direction 3 to the mechanical stress in the direction 3, at constant electric field (for $E = 0$: short circuit).

s_{55}^D the ratio of a shear strain to the effective shear stress at constant dielectric displacement (for $D = 0$: open electrodes).

The often used elasticity or Young's modulus Y_{ij} corresponds in a first approximation to the reciprocal value of the corresponding elasticity coefficient.

Frequency Coefficient N_i

The frequency coefficient N describes the relationship between the geometrical dimension A of a body and the corresponding (series) resonance frequency. The indices designate the corresponding direction of oscillation $N = f_r A$.

Examples

N_3 describes the frequency coefficient for the longitudinal oscillation of a slim rod polarized in the longitudinal direction.

N_t is the frequency coefficient for the transverse oscillation of a slim rod polarized in the 3-direction.

N_s is the frequency coefficient of the thickness shear oscillation of a thin disk.

N_p is the frequency coefficient of the planar oscillation of a round disk.

N_t is the frequency coefficient of the thickness oscillation of a thin disk polarized in the thickness direction.

Mechanical Quality Factor Q_m

The mechanical quality factor Q_m characterizes the "sharpness of the resonance" of a piezoelectric body or resonator and is primarily determined from the 3 dB bandwidth of the series resonance of the system which is able to oscillate (see Fig. 7 typical impedance curve). The reciprocal value of the mechanical quality factor is the mechanical loss factor, the ratio of effective resistance to reactance in the equivalent circuit diagram of a piezoelectric resonator at resonance (Fig. 6).

Coupling Factors k

The coupling factor k is a measure of how the magnitude of the piezoelectric effect is (not an efficiency factor!) It describes the ability of a piezoelectric material to convert electrical energy into mechanical energy and vice versa. The coupling factor is determined by the square root of the ratio of stored mechanical energy to the total energy absorbed. At resonance, k is a function of the corresponding form of oscillation of the piezoelectric body.

Examples

k_{33} the coupling factor for the longitudinal oscillation.

k_{31} the coupling factor for the transverse oscillation.

k_p the coupling factor for the planar radial oscillation of a round disk.

k_t the coupling factor for the thickness oscillation of a plate.

k_{15} the coupling factor for the thickness shear oscillation of a plate.

Dynamic Behavior

OSCILLATION MODES OF PIEZOCERAMIC ELEMENTS

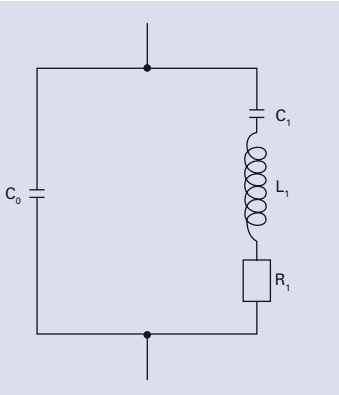

Fig .6 .Equivalent circuit diagram of a piezoelectric resonator

The electromechanical behavior of a piezo - electric element excited to oscillations can be represented by an electrical equivalent circuit diagram (s . Fig .6) . C_0 is the capacitance of the dielectric . The series circuit, consisting of C_1 , L_1 , and R_1 , describes the change in the mechanical properties, such as elastic deformation, effective mass (inertia) and mechanical losses resulting from internal friction . This description of the oscillatory circuit can only be used for frequencies in the vicinity of the mechanical intrinsic resonance .

Most piezoelectric material parameters are determined by means of impedance measurements on special test bodies according to the European Standard EN 50324-2 at resonance .

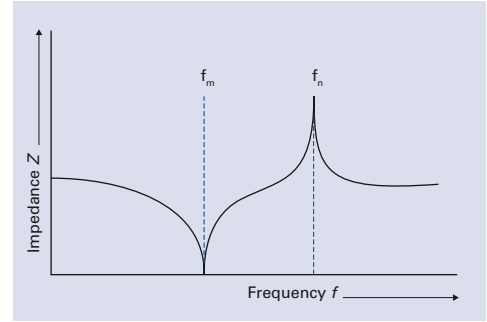

Fig .7 .Typical impedance curve

Shape	Oscillations		
	Type	Mechanical deformation	Series resonance frequency
Thin disk 	radial		$f_s = \frac{N}{OD}$
	thickness		$f_s = \frac{N}{TH}$
Plate 	transverse		$f_s = \frac{N}{L}$
Rod 	longitudinal		$f_s = \frac{N}{L}$
Shear plate 	thickness shear		$f_s = \frac{N}{TH}$
Tube 	transversal		$f_s \approx \frac{N}{L}$
	thickness		$f_s \approx \frac{N}{TH}$

Figure 7 illustrates a typical impedance curve. The series and parallel resonances, f_s and f_p , are used to determine the piezoelectric parameters. These correspond to a good approximation to the impedance minimum f_{min} and maximum f_{max} .

Oscillation States of Piezoelectric Components

Oscillation states or modes and the deformation are decided by the geometry of the element, mechano-elastic properties and the orientations of the electric field and the polarization. Coefficients see p. 10, specific values see p. 18, dimensions see p. 27. The equations are used to calculate approximation values.

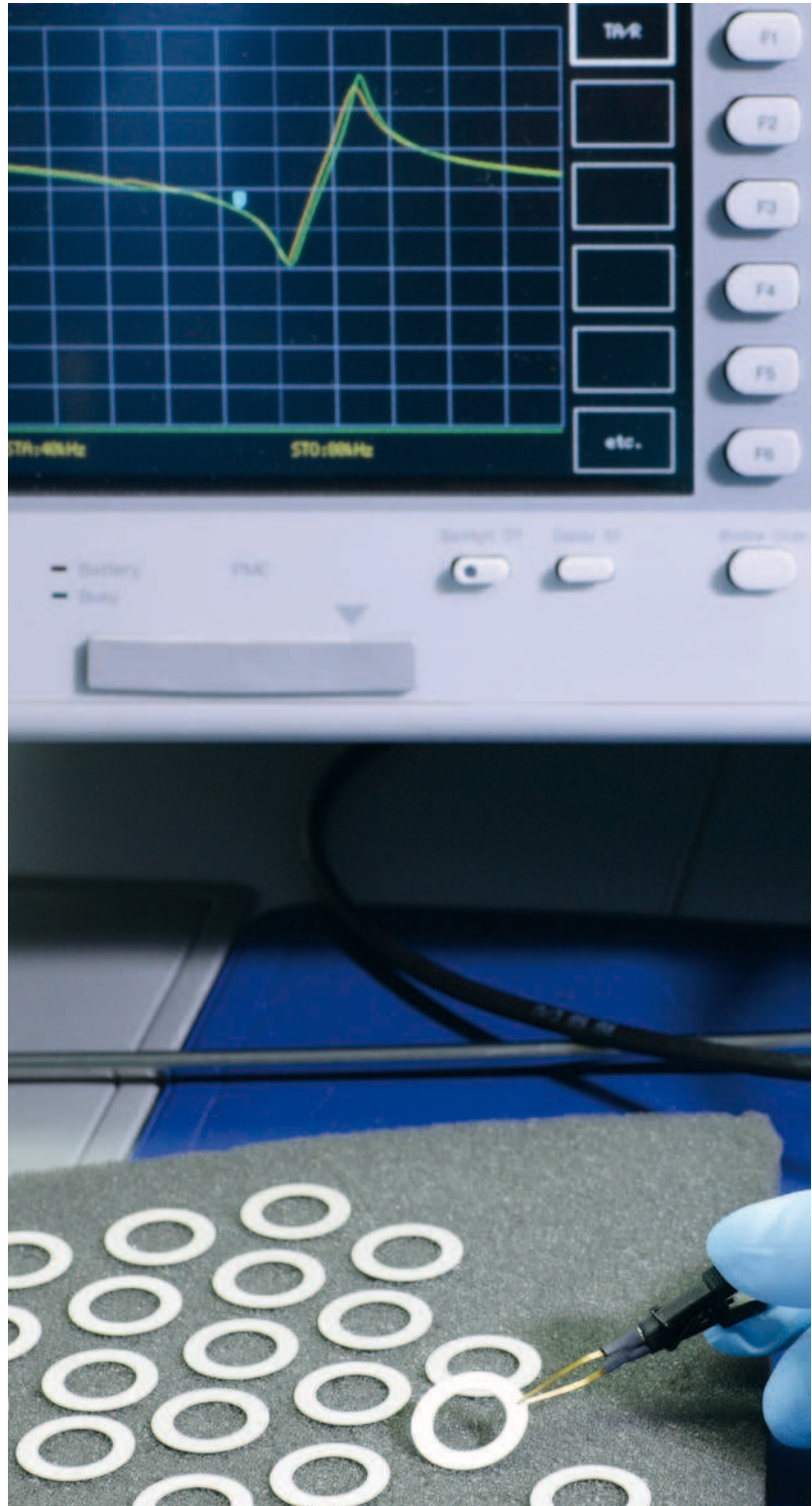

Electrically induced displacement (small signal)	Mechanically induced voltage (small signal)
$\Delta OD = \frac{d_{31} OD}{TH} U$	
$\Delta TH = d_{33} U$	$U = -\frac{4g_{31} TH}{\pi OD^2} F_3$
$\Delta L = \frac{d_{31} L}{TH} U$	$U = -\frac{g_{31}}{W} F_1$
$\Delta L = d_{33} U$	$U = -\frac{g_{31} L}{W TH} F_3$
$\Delta L = d_{15} U$	$U = -\frac{g_{15} TH}{L W} F_3$
$\Delta L = \frac{d_{31} L}{TH} U$	
$\Delta TH = d_{33} U$	

Material Properties and Classification

PI Ceramic provides a wide selection of piezoelectric ceramic materials based on modified Lead Zirconate Titanate (PZT) and Barium Titanate. The material properties are classified according to the EN 50324 European Standard.

In addition to the standard types described here in detail, a large number of modifications are available which have been adapted to a variety of applications.

Internationally, the convention is to divide piezo ceramics into two groups. The terms “soft” and “hard” PZT ceramics refer to the mobility of the dipoles or domains and hence also to the polarization and depolarization behavior.

“Soft” Piezo Ceramics

Characteristic features are a comparably high domain mobility and resulting “soft ferroelectric” behavior, i.e. it is relatively easy to polarize. The advantages of the “soft” PZT materials are their large piezoelectric charge coefficient, moderate permittivities and high coupling factors.

Important fields of application for “soft” piezo ceramics are **actuators** for micro-positioning and nanopositioning, **sensors** such as conventional vibration pickups, ultrasonic transmitters and receivers for flow or level measurement, for example, object identification or monitoring as well as **electro-acoustic applications** as sound transducers and microphones, through to their use as sound pickups on musical instruments.

“Hard” Piezo Ceramics

“Hard” PZT materials can be subjected to high electrical and mechanical stresses. Their properties change only little under these conditions and this makes them particularly ideal for high-power applications. The advantages of these PZT materials are the moderate permittivity, large piezoelectric coupling factors, high qualities and very good stability under high mechanical loads and operating fields. Low dielectric losses facilitate their continuous use in resonance mode with only low intrinsic warming of the component. These piezo elements are used in ultrasonic cleaning (typically kHz frequency range), for example, the machining of materials (ultrasonic welding, bonding, drilling, etc.), for ultrasonic processors (e.g. to disperse liquid media), in the medical field (ultrasonic tartar removal, surgical instruments etc.) and also in sonar technology.



Lead-Free Materials

Piezoelectric ceramics, which nowadays are based mainly on Lead Zirconate-Lead Titanate compounds, are subject to an exemption from the EU directive to reduce hazardous substances (RoHS) and can therefore be used without hesitation. PI Ceramic is nevertheless aiming to provide high-performance lead-free piezoceramic materials and thus provide materials with a guaranteed future. PI Ceramic is currently investigating technologies to reliably manufacture lead-free ceramic components in series production.

First Steps Towards Industrial Use with PIC700

The PIC700 material, which is currently in laboratory production, is the first lead-free piezoceramic material being offered on

the market by PI Ceramic. PIC700 is based on Bismuth Sodium Titanate (BNT) and has very similar characteristics to Barium Titanate materials. PIC700 is suitable for ultrasonic transducers in the MHz range as well as sonar and hydrophone applications.

Characteristics of the Lead-Free Piezo Ceramic Material

The maximum operating temperature of the BNT-based ceramic is around 200 °C. The permittivity and piezoelectric coupling factors of BNT components are lower than those of conventional, PZT materials. Even though PIC700 is suitable for a number of applications, an across-the-board replacement for PZT piezoelectric elements in technical applications is not in sight at the moment.



Typical dimensions of current PIC 700 components are diameters of 10 mm and thicknesses of 0.5 mm.

Crystalline Piezo Material for Actuators

Lead-Free and with High Linearity

Piezoceramic actuators exhibit nonlinear displacement behavior: The voltage applied is thus not a repeatable measure for the position reached. Sensors must therefore be used in applications where the position is relevant. The crystalline PIC050 material, in contrast, has a linearity which is significantly improved by a factor of 10 so that a position sensor is not necessary.

PIC050 is used for actuators and nanopositioning systems with the tradename Picoactuator. They have the high stiffness and dynamics of actuators made of PZT material but their displacement is limited: Travel of up to $\pm 3 \mu\text{m}$ results with a maximum profile of 20 mm.

Picoactuator® in Nanopositioning

In precision positioning technology, Physik Instrumente (PI) uses these actuators precisely where this small displacement with high dynamics and accuracy is required. The high linearity means that they can operate without position control which otherwise sets an upper limit for the dynamics of the system as a result of the limited control bandwidth.

Since it is used in positioning systems the PIC050 material is only supplied as a translational or shear actuator in predefined shapes. The standard dimensions are similar to those of the PICA shear actuators (see www.piceramic.com).



High-dynamics nanopositioning system with Picoactuator technology.

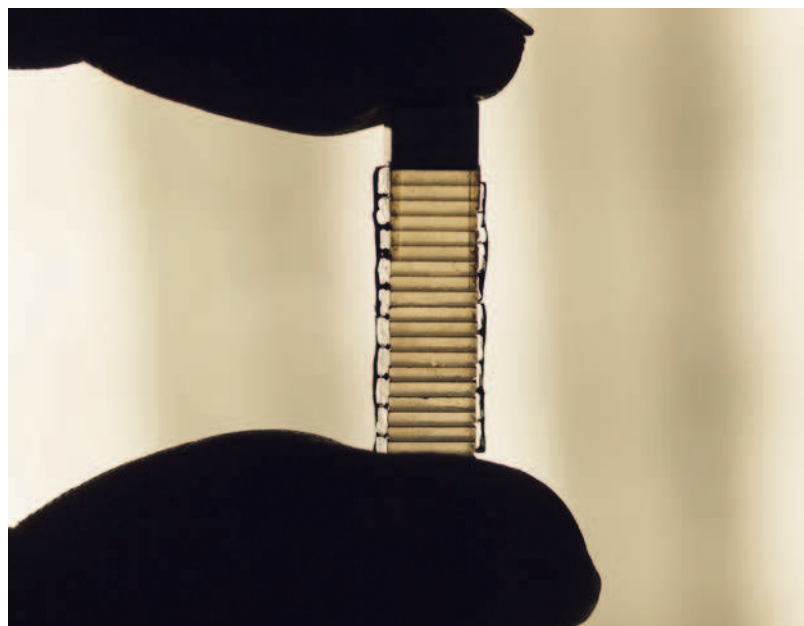

The PIC050 crystal forms translucent layers in the Picoactuator.

Material Properties and Classification

Material designation	General description of the material properties "Soft" -PZT	Classification in accordance with EN 50324-1	ML-Standard DOD-STD-1376A
PIC151	<p>Material: Modified Lead Zirconate-Lead Titanate</p> <p>Characteristics: High permittivity, large coupling factor, high piezoelectric charge coefficient</p> <p>Suitable for: Actuators, low-power ultrasonic transducers, low-frequency sound transducers .Standard material for actuators of the PICA series: PICA Stack, PICA Thru</p>	600	II
PIC255	<p>Material: Modified Lead Zirconate-Lead Titanate</p> <p>Characteristics: Very high Curie temperature, high permittivity, high coupling factor, high charge coefficient, low mechanical quality factor, low temperature coefficient</p> <p>Suitable for: Actuator applications for dynamic operating conditions and high ambient temperatures (PICA Power series), low-power ultrasonic transducers, non-resonant broadband systems, force and acoustic pickups, DuraAct patch transducers, PICA Shear shear actuators</p>	200	II
PIC155	<p>Material: Modified Lead Zirconate-Lead Titanate</p> <p>Characteristics: Very high Curie temperature, low mechanical quality factor, low permittivity, high sensitivity (g coefficients)</p> <p>Suitable for: Applications which require a high g coefficient (piezoelectric voltage coefficient), e.g. for microphones and vibration pickups with preamplifier, vibration measurements at low frequencies</p>	200	II
PIC153	<p>Material: Modified Lead Zirconate-Lead Titanate</p> <p>Characteristics: extremely high values for permittivity, coupling factor, high charge coefficient, Curie temperature around 185 °C</p> <p>Suitable for: Hydrophones, transducers in medical diagnostics, actuators</p>	600	VI
PIC152	<p>Material: Modified Lead Zirconate-Lead Titanate</p> <p>Characteristics: Very high Curie temperature</p> <p>Suitable for: Use at temperatures up to 250 °C (briefly up to 300 °C) .</p>	200	II

Material designation	General description of the material properties "Hard" -PZT	Classification in accordance with EN 50324-1	ML-Standard DOD-STD-1376A
PIC181	Material: Modified Lead Zirconate-Lead Titanate Characteristics: Extremely high mechanical quality factor, good temperature and time constancy of the dielectric and elastic values Suitable for: High-power acoustic applications, applications in resonance mode	100	I
PIC184	Material: Modified Lead Zirconate-Lead Titanate Characteristics: Large electromechanical coupling factor, moderately high quality factor, excellent mechanical and electrical stability Suitable for: High-power ultrasound applications, hydroacoustics, sonar technology	100	I
PIC144	Material: Modified lead zirconate titanate Characteristics: Large electromechanical coupling factor, high quality factor, excellent mechanical and electrical stability, high compressive resistance Suitable for: High-power ultrasound applications, hydroacoustics, sonar technology	100	I
PIC241	Material: Modified Lead Zirconate-Lead Titanate Characteristics: High mechanical quality factor, higher permittivity than PIC181 Suitable for: High-power acoustic applications, piezomotor drives	100	I
PIC300	Material: Modified Lead Zirconate-Lead Titanate Characteristics: Very high Curie temperature Suitable for: Use at temperatures up to 250 °C (briefly up to 300 °C)	100	I

	Lead-Free Materials		
PIC050	Material: Spezial crystalline material Characteristics: Excellent stability, Curie temperature >500 °C Suitable for: High-precision, hysteresis-free positioning in open-loop operation, Picoactuator		
PIC700	Material: Modified Bismuth Sodium Titanate Characteristics: Maximum operation temperature 200 °C, low density, high coupling factor of the thickness mode of vibration, low planar coupling factor Suitable for: Ultrasonic transducers > 1MHz		

Material Data

SPECIFIC PARAMETERS OF THE STANDARD MATERIALS

		Ferroelectric soft PZT materials				
		Unit	PIC151	PIC255/ PIC252 ¹⁾	PIC155	PIC153
Physical and dielectric properties						
Density	ρ	g / cm ³	7.80	7.80	7.75	7.60
Curie temperature	T_c	°C	250	350	340	160
Relative permittivity	in the polarization direction	$\epsilon_{33}^T / \epsilon_0$	2500	1800	1600	4500
	⊥ to polarity	$\epsilon_{11}^T / \epsilon_0$	1980	1750	1850	3500
Dielectric loss factor	$\tan \delta$	10 ⁻³	20	20	25	30
Electromechanical properties						
Coupling factor	k_p		0.62	0.62	0.62	0.62
	k_t		0.53	0.47	0.48	0.49
	k_{31}		0.38	0.35	0.35	0.33
	k_{33}		0.69	0.69	0.69	0.72
	k_{15}		0.65	0.66	0.65	0.66
Piezoelectric charge coefficient	d_{31}		-210	-180	-165	-295
	d_{33}	10 ⁻¹² C/N	500	400	360	600
	d_{15}		610	550	540	780
Piezoelectric voltage coefficient	g_{31}	10 ⁻³ Vm/N	-10.1	-11.8	-12.8	-7.9
	g_{33}		21.5	25	27.9	16.4
Acousto-mechanical properties						
Frequency coefficients	N_p		1940	2000	1930	1940
	N_t		1500	1420	1500	1380
	N_s	Hz · m	1360	1370	1340	1345
	N_i		1950	2000	1990	2020
Elastic compliance coefficient	S_{11}^E	10 ⁻¹² m ² /N	16.4	16	16.1	17.2
	S_{33}^E		19.4	19	19.3	20
Elastic stiffness coefficient	C_{33}^D	10 ¹⁰ N/m ²	15.7	15.4	15.8	15.5
Mechanical quality factor	Q_m		100	80	80	50
Temperature stability						
Temperature coefficient of ϵ_{33}^T (in the range -20 °C to +125 °C)	$TK \epsilon_{33}$	10 ⁻³ /K	4	4	5	26
Time stability (relative change of the parameter per decade of time in %)						
Relative permittivity	C_ϵ			-10	-20	
Coupling factor	C_κ			-10	-20	

Ferroelectric hard PZT materials						Lead-free materials	
PIC152	PIC181	PIC184 ²⁾	PIC144 ²⁾	PIC241	PIC300	PIC700 ²⁾ (BNT)	PIC701 ²⁾ (BNT)
7.75	7.85	7.75	7.90	7.80	7.75	5.7	5.7
340	330	320	320	270	370	190 ³⁾	230 ³⁾
1350	1200	1200	1300	1750	1030	680	542
1100	1250	1250	1500	1500	960	655	629
15	3	3	3	5	3	30	30
0.48	0.56	0.55	0.60	0.55	0.47	0.14	0.13
0.41	0.46	0.44	0.48	0.45	0.41	0.41	0.39
0.25	0.32	0.30	0.30	0.32	0.27	0.09	0.08
0.58	0.66	0.63	0.66	0.65	0.57	0.43	0.37
0.46	0.63	0.65	0.65	0.63	0.48	0.25	0.31
-90	-120	-99	-105	-140	-85	-20	-17
240	265	220	225	300	190	100	71
235	475	421	419	431	248	90	108
-8,7	-10,6	-10,7	-10,4	-9,2	-9,3	-3,3	-3,5
23,4	23	22,4	23,3	19,9	20,8	16	14,8
2280	2270	2175	2170	2200	2400	2984	3071
1570	1640	1590	1620	1590	1700	2228	2302
1530	1560	1560	1540	1550	1700	2420	2403
2100	2110	2035	2035	2020	2100	2576	2503
13,1	11,8	12,2	12,4	12,6	11,2	8,8	8,2
14,8	13,3	13,7	14,3	14,4	12	9,1	7,5
16,6	17	15,8	16,6	15,5	16,3	15,1	13,5
100	2000	400	1000	500	1400	100	100
2	3	4		3	2		
		-4.0					
		-2.0					

Recommended operating temperature PZT: 50 % of Curie temperature .

- 1) Material for the Multilayer tape technology
- 2) Preliminary data, subject to change
- 3) Depolarization temperature

The following values are valid approximations for all PZT materials from PI Ceramic:

Specific heat capacity:

$$WK = \text{approx. } 350 \text{ J kg}^{-1} \text{ K}^{-1}$$

Specific thermal conductivity :

$$WL = \text{approx. } 1.1 \text{ W m}^{-1} \text{ K}^{-1}$$

Poisson's ratio (lateral contraction):

$$\sigma = \text{approx. } 0.34$$

Coefficient of thermal expansion:

$$\alpha_3 = \text{approx. } -4 \text{ to } -6 \times 10^{-6} \text{ K}^{-1}$$

(in the polarization direction, shorted)

$$\alpha_1 = \text{approx. } 4 \text{ to } 8 \times 10^{-6} \text{ K}^{-1}$$

(perpendicular to the polarization direction shorted)

Static compressive strength: >600 MPa

The following values are valid approximations for all lead-free materials from PI Ceramic:

Specific heat capacity:

$$WK \text{ BNT} = \text{approx. } 350 \text{ J kg}^{-1} \text{ K}^{-1}$$

Specific thermal conductivity :

$$WL \text{ BNT} = \text{approx. } 1.1 \text{ W m}^{-1} \text{ K}^{-1}$$

The data was determined using test pieces with the geometric dimensions laid down in EN 50324-2 standard and are typical values.

All data provided was determined 24 to 48 h after the time of polarization at an ambient temperature of $23 \pm 2 \text{ }^\circ\text{C}$.

A complete coefficient matrix of the individual materials is available on request. If you have any questions about the interpretation of the material characteristics please contact PI Ceramic (info@piceramic.com).

For material characteristics of KNN please visit our webpage: www.piceramic.com

Temperature Dependence of the Coefficients

Temperature curve of the capacitance C

① Materials: PIC151, PIC255 and PIC155

② Materials: PIC181, PIC241 and PIC300

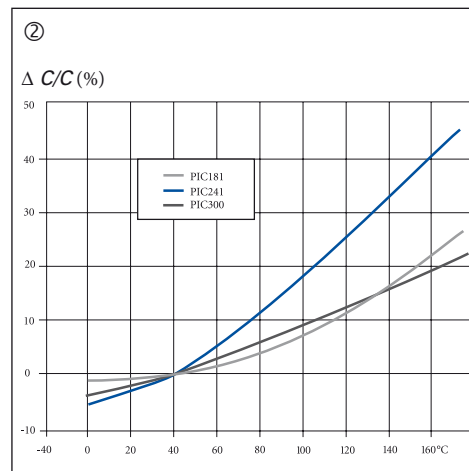
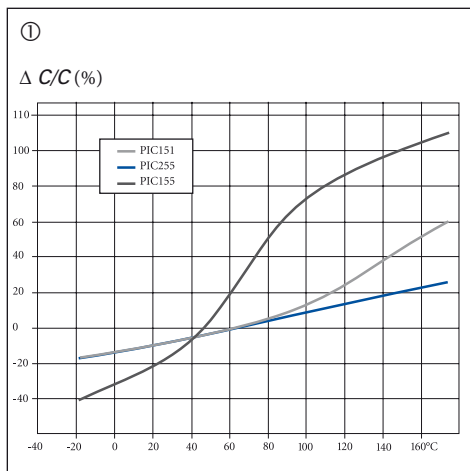

Temperature curve of the resonant frequency of the transverse oscillation f_s

③ Materials: PIC151, PIC255 and PIC155

④ Materials: PIC181, PIC241 and PIC300

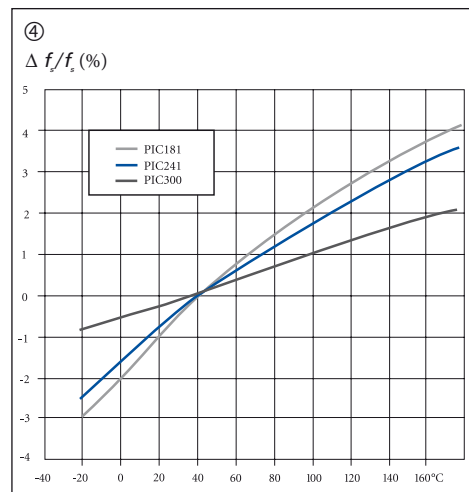
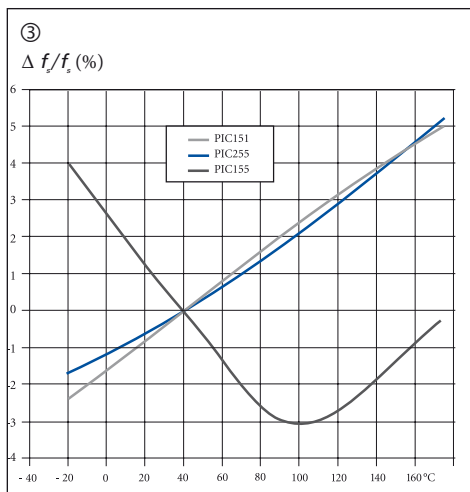

Temperature curve of the coupling factor of the transverse oscillation k_{31}

⑤ Materials: PIC151, PIC255 and PIC155

⑥ Materials: PIC181, PIC241 and PIC300

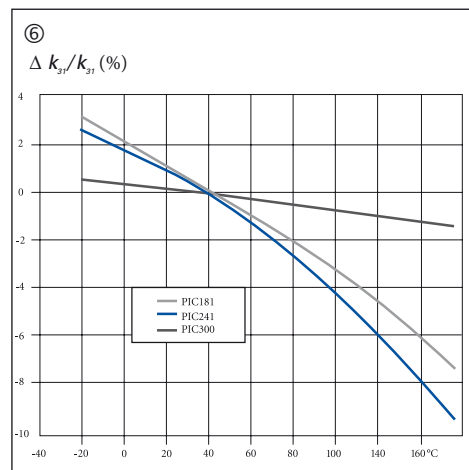
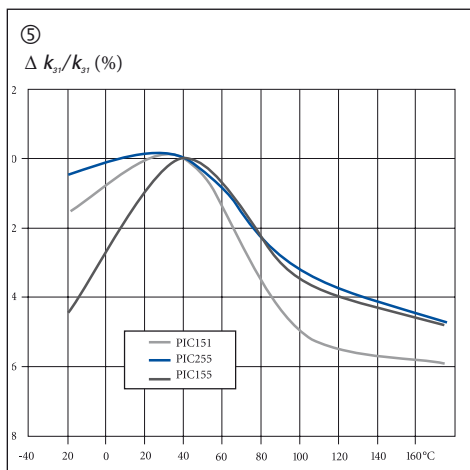

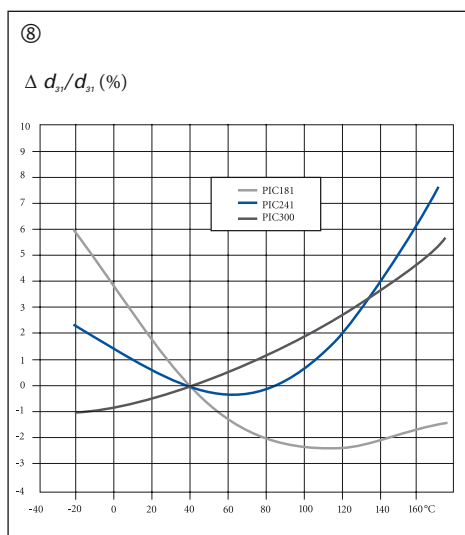
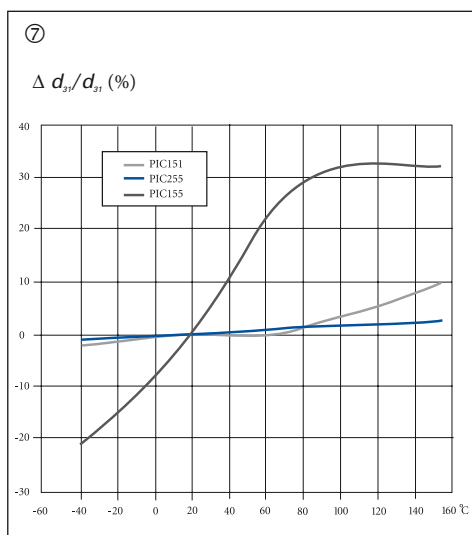

Temperature curve of the piezoelectric charge coefficient d_{31}

⑦ Materials: PIC151, PIC255 and PIC155

⑧ Materials: PIC181, PIC241 and PIC300

Specific Characteristics

Thermal properties using the example of the PZT ceramic PIC255

- The thermal strain exhibits different behavior in the polarization direction and perpendicular to it .
- The preferred orientation of the domains in a polarized PZT body leads to an anisotropy . This is the cause of the varying thermal expansion behavior .
- Non-polarized piezoceramic elements are

isotropic . The coefficient of expansion is approximately linear with a TK of approx $2 \cdot 10^{-6} / K$.

- The effect of successive temperature changes must be heeded particularly in the application . Large changes in the curve can occur particularly in the first temperature cycle .
- Depending on the material, it is possible that the curves deviate strongly from those illustrated .

Thermal strain in the polarization direction $\Delta L/L$ (%)

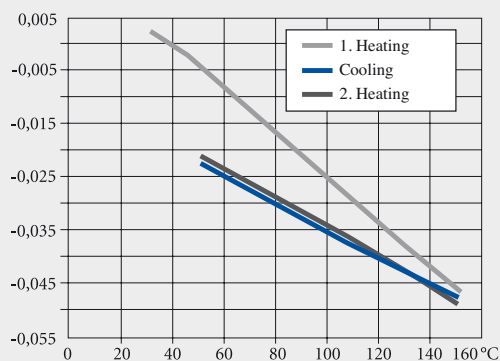

Thermal strain perpendicular to the polarization direction $\Delta L/L$ (%)

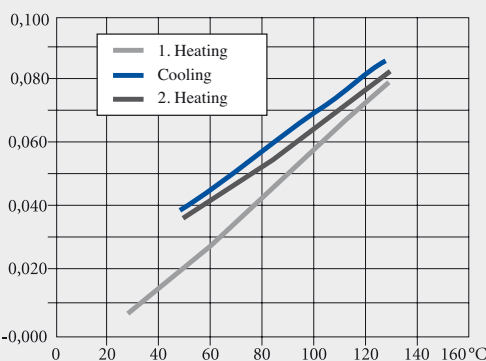

Manufacturing Technology

EFFICIENT PROCESSES FOR SMALL, MEDIUM-SIZED AND LARGE PRODUCTION RUNS



Manufacture of Piezo Components Using Pressing Technology

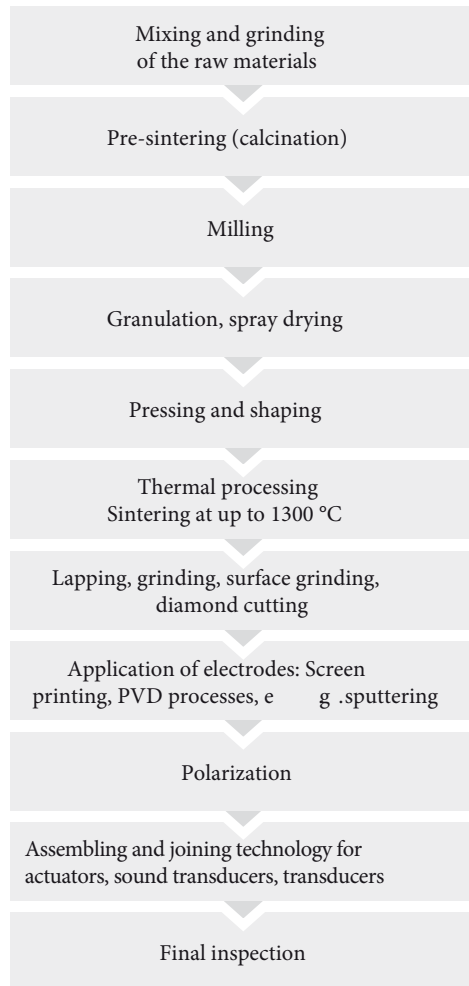

Piezoceramic disks with center hole

Piezo Components Made by Pressing Technology

Piezoceramic bulk elements are manufactured from spray-dried granular material by mechanical hydraulic presses. The components are either manufactured true to size, taking into account the sintering contraction, or with machining excesses which are then reworked to achieve the required precision.

The sintered ceramic material is hard and can be sawn and machined, if required. Screen printing is used to metallize the piezo elements and sputtering processes (PVD) are employed for thin metallizing layers. The sintered elements are then polarized.

Stack Design for Actuators

Piezo actuators are constructed by stacking several piezoceramic bulk elements and intermediate metal foils. Afterwards an outer insulation layer made of polymer material is applied.

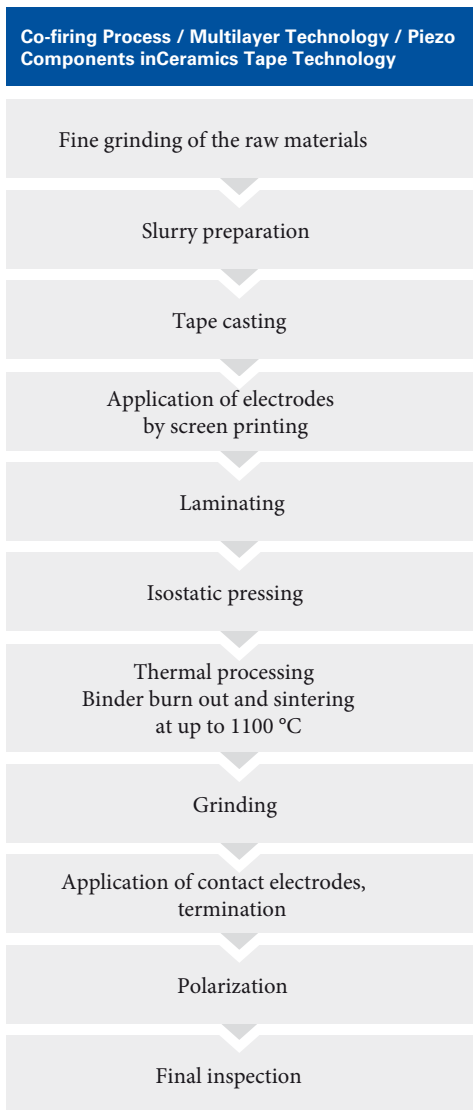

Film Technology for Thin Ceramics Components

Thin ceramic layers are produced by tape casting. This process can achieve minimal individual component thicknesses of only 50 µm.

The electrodes are then applied with special screen printing or PVD processes.

Multilayer Piezo Actuators: PICMA®

Multilayer co-firing technology is an especially innovative manufacturing process. The first step is to cast tapes of piezoceramic materials which are then provided with electrodes while still in the green state. The component is then laminated from individual layers. In the following electrodes and ceramic are sintered together in a single processing step.

The patented PICMA® design comprises an additional ceramic insulation layer which protects the inner electrodes from environmental effects. Any further coatings made of polymer material, for example, are therefore not required. This means that PICMA® piezo actuators remain stable even when subject to high dynamic load. They achieve a higher reliability and a lifetime which is ten times longer than conventional multilayer piezo actuators with a polymer insulation.

After the mechanical post-processing is complete, the multilayer actuators are provided with contact electrodes and are polarized.

PICMA® actuators with patented, meander-shaped external electrodes for up to 20 A charging current

Flexibility in Shape and Design

Shaping of Compacts

Components such as disks or plates can be manufactured at low cost with a minimum thickness from as low as 0.2 mm. Inboard automatic cutoff saws produce such pieces in large numbers.

Modern CNC technology means the sintered ceramic elements can be machined with the highest precision. Holes with diameters of down to 0.3 mm can be produced. Almost any contours can be shaped with accuracies to one tenth of a millimeter. Surfaces can be structured and the components can be milled to give a three-dimensional fit.

Ultrasonic machining processes are used to manufacture thin-walled tubes with wall thicknesses of 0.5 mm.

Robot-Assisted Series Production

Automated assembly and production lines use fast pick-and-place devices and computer-controlled soldering processes, for example. An annual production run of several million piezoelectric components and more is thus no problem.

All Possible Shapes Even with Full-Ceramic Encapsulation

PI Ceramic can manufacture almost any shape of PICMA® multilayer piezo actuator using the latest production technology. Hereby, all surfaces are encapsulated with ceramic insulation.

We can manufacture not only various basic shapes, e.g. round or triangular cross-sections, but also insulated center holes on benders, chips or stack actuators, making it easier to integrate them.

Special milling machines work the sensitive ceramic films in the green state, i.e. before sintering. The individual layers are then equipped with electrodes and laminated. The co-firing process is used to sinter the ceramic and the internal electrodes together, the same process as with PICMA® standard actuators.

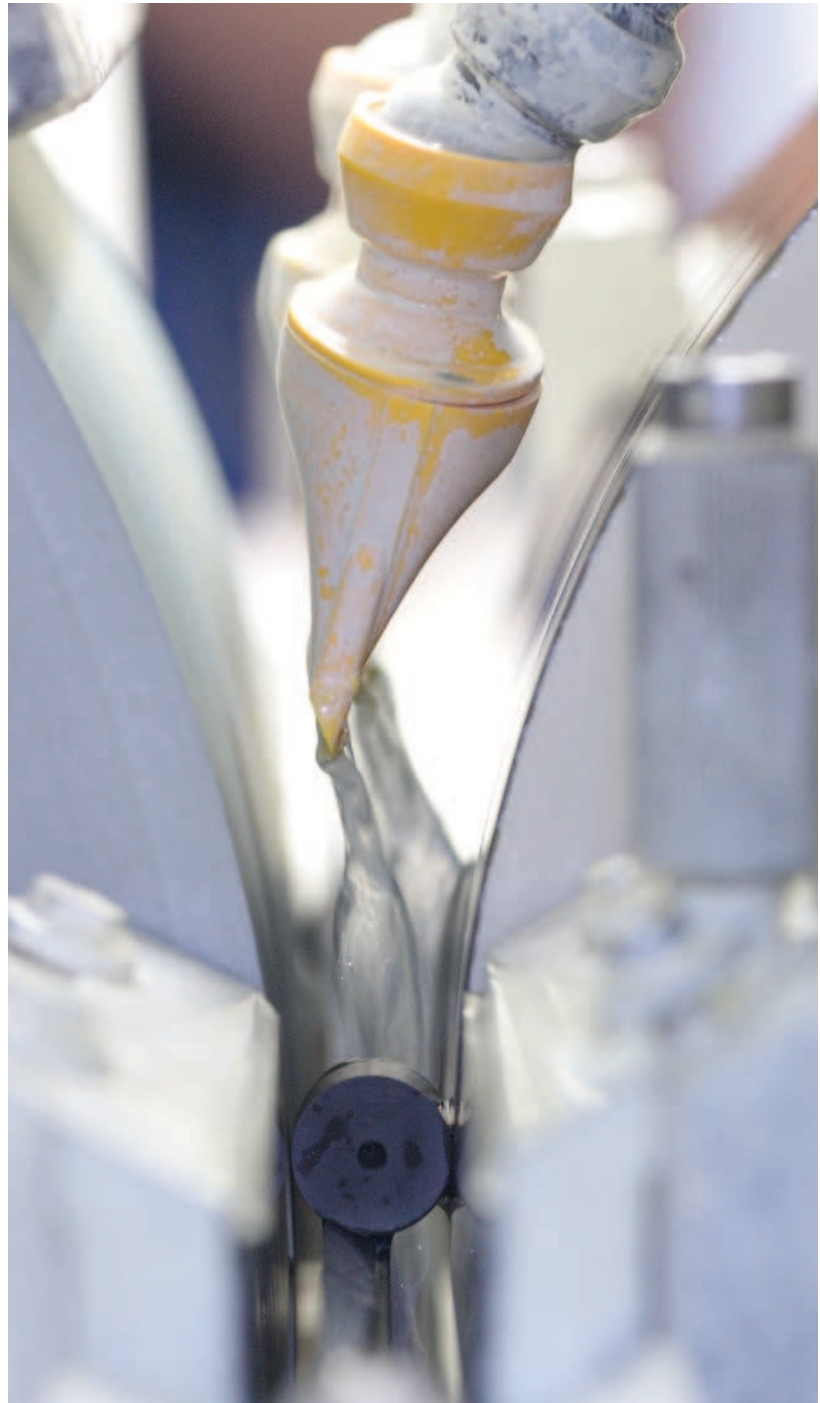

Centerless, cylindrical grinding of piezoceramic rods

PICMA® Multilayer Actuators with Long Lifetime



Automatic soldering machine with PICMA® actuators

The internal electrodes and the ceramic of PICMA® multilayer actuators are sintered together (co-firing technology) to create a monolithic piezoceramic block. This process creates an encapsulating ceramic layer which provides protection from humidity and from failure caused by increased leakage current. PICMA® actuators are therefore far superior to conventional, polymer-insulated multilayer piezo actuators in terms of reliability and lifetime. The monolithic ceramic design also gives rise to a high resonance frequency, making the actuators ideal for high-dynamic operation.

Large Temperature Range – Optimum UHV Compatibility – Minimal Outgassing – Neutral in Magnetic Fields

The particularly high Curie temperature of 320 °C gives PICMA® actuators a usable temperature range of up to 150 °C, far beyond the 80 °C limit of conventional multilayer actuators. This and the exclusive use of inorganic materials provide the optimum conditions for use in ultra-high vacuums: No

outgassing and high bake-out temperatures. PICMA® piezo actuators even operate in the cryogenic temperature range, albeit at reduced travel. Every actuator is constructed exclusively of non-ferromagnetic materials, giving them extremely low residual magnetism of the order of a few nanotesla.

Low Operating Voltage

In contrast to most commercially available multilayer piezo actuators, PICMA® actuators achieve their nominal displacement at operating voltages far below 150 V. This characteristic is achieved by using a particularly fine-grained ceramic material which means the internal layers can be thin.

The PICMA® actuators are at least partially protected by the following patents:

- German Patent No .10021919
- German Patent No .10234787
- German Patent No .10348836
- German Patent No .102005015405
- German Patent No .102007011652
- US Patent No .7,449,077

Metallization and Assembling Technology

THE COMPLETE PROCESS IS IN-HOUSE

Thick-Film Electrodes

Screen printing is a standard procedure to apply the metal electrodes to the piezoceramic elements. Typical film thicknesses here are around $10\ \mu\text{m}$. Various silver pastes are used in this process. After screen printing these pastes are baked on at temperatures above $800\ ^\circ\text{C}$.

Thin-Film Electrodes

Thin-film electrodes are applied to the ceramic using modern PVD processes (sputtering). The typical thickness of the metallization is in the range of $1\ \mu\text{m}$. Shear elements must be metallized in the polarized state and are generally equipped with thin-film electrodes.

PI Ceramic has high-throughput sputtering facilities which can apply electrodes made of metal alloys, preferably CuNi alloys and noble metals such as gold and silver.

Soldering Methods

Ready-made piezo components with connecting wires are manufactured by specially trained staff using hand soldering processes. We have the latest automatic

soldering machines at our disposal to solder on miniaturized components and for larger production runs. Soldered joints which must be extremely reliable undergo special visual inspections. The optical techniques used for this purpose range from the stereomicroscope through to camera inspection systems.

Mounting and Assembling Technology

The joining of products, e.g. with adhesives, is carried out in the batch production using automated equipment which executes the necessary temperature-time-regime (e.g. curing of epoxy adhesives) and hence guarantees uniform quality. The choice of adhesive and the curing regime are optimized for every product, taking into consideration the material properties and the intended operational conditions. Specifically developed dosing and positioning systems are used for complex special designs. The piezoceramic stack actuators of the PICA series, high-voltage bender-type actuators and ultrasonic transducers are constructed in jointing processes and have proved successful many times over in the semi-conductor industry and in medical engineering thanks to their high reliability.



Fully loaded sputtering equipment

Piezoceramic Components

DIMENSIONS

	Disk / rod / cylinder	Outer diameter OD: 2 to 80 mm Thickness TH: 0.15 to 30 mm
	Plate / block	Length L: 1 to 80 mm, Width W: 1 to 60 mm, Thickness TH: 0.1 to 30 mm
	Shear plate	Length L: max 75 mm, Width W: max 25 mm, Thickness TH: 0.2 to 10 mm
	Tube	Outer diameter OD: 2 to 80 mm, Inner diameter ID: 0.8 to 74 mm, Length L: max 30 mm
	Ring	Outer diameter OD: 2 to 80 mm, Inner diameter ID: 0.8 to 74 mm, Thickness TH: max 70 mm
	Bender elements constructed in series / parallel	Length L: 3 to 50 mm, Width W: 1 to 25 mm, Thickness TH: 0.4 to 1.5 mm Round bender elements on request Preferred dimensions: Diameter: 5 to 50 mm, Thickness: 0.3 to 2 mm

- P indicates the poling direction.
- The dimensions are mutually dependent and cannot be chosen arbitrarily.
- The minimum dimensions are determined by physical and technological limits. The thickness or wall thickness, for example, is limited by the mechanical strength of the ceramic during machining.
- Maximum thickness for polarization: 30 mm

Labeling of the polarity

The surface of the electrode which is at the positive potential during polarization is marked with a dot or a cross. Alternatively and particularly for thin-film electrodes the direction of polarization is marked by coloring the electrode material: A reddish color indicates the electrode which was at the positive potential during the polarization.

Standard tolerances	Dimension	Tolerance
Dimensions, as fired ± 0.3 mm resp. $\pm 3\%$	Deviation from flatness (slight bending of thin disks or plates is not taken into account)	< 0.02 mm
Length L, width W (dimensions; tolerance) < 15 mm; ± 0.15 mm < 40 mm; ± 0.25 mm < 20 mm; ± 0.20 mm < 80 mm; ± 0.30 mm	Deviation from parallelism	< 0.02 mm
Outer diameter OD, inner diameter ID (dimensions; tolerance) < 15 mm; ± 0.15 mm < 40 mm; ± 0.25 mm < 20 mm; ± 0.20 mm < 80 mm; ± 0.30 mm	Deviation from concentricity	≤ 0.4 mm
Thickness TH (dimensions; tolerance) < 10 mm; ± 0.05 mm < 40 mm; ± 0.15 mm < 20 mm; ± 0.10 mm < 80 mm; ± 0.20 mm	Frequency tolerance	$\pm 5\%$ (< 2 MHz) $\pm 10\%$ (≥ 2 MHz)
	Tolerance of electric capacitance	$\pm 20\%$

Standard Dimensions

- ① Electrodes: Fired silver (thick film) or PVD (thin film, different materials: e.g. CuNi or Au)
- ② Points: Resonant frequency > 1 MHz
- Circles: Resonant frequency < 1 MHz
- Electrodes: Fired silver (thick film) or PVD (thin film, different materials: e.g. CuNi or Au)
- ③ Electrodes: Fired silver (thick film) or CuNi or Au (thin film)

Components with standard dimensions can be supplied at very short notice on the basis of semi-finished materials in stock. Extreme

values cannot be combined. Geometries which exceed the standard dimensions are available on request.

① Disk / rod / cylinder

TH	OD in mm									
in mm	3	5	10	16	20	25	35	40	45	50
0.20	●	●	●	●	●					
0.25	●	●	●	●	●					
0.30	●	●	●	●	●	●				
0.40	●	●	●	●	●	●	●			
0.50	●	●	●	●	●	●	●	●	●	
0.75	●	●	●	●	●	●	●	●	●	●
1.00	●	●	●	●	●	●	●	●	●	●
2.00	●	●	●	●	●	●	●	●	●	●
3.00	●	●	●	●	●	●	●	●	●	●
4.00	●	●	●	●	●	●	●	●	●	●
5.00	●	●	●	●	●	●	●	●	●	●
10.00	●	●	●	●	●	●	●	●	●	●
20.00	●	●	●	●	●	●	●	●	●	●

② Disk / rod

with defined resonant frequency

TH	OD in mm									
in MHz	3	5	10	16	20	25	35	40	45	50
10.00	●	●	●	●	●					
5.00	●	●	●	●	●	●				
4.00	●	●	●	●	●	●	●			
3.00	●	●	●	●	●	●	●	●		
2.00		●	●	●	●	●	●	●	●	●
1.00			●	●	●	●	●	●	●	●
0.75			○	○	○	○	○	○	○	○
0.50				○	○	○	○	○	○	○
0.40					○	○	○	○	○	○
0.25							○	○	○	○
0.20								○	○	○

③ Plate / block

TH	LxW in mm ²									
in mm	4 x 4	5 x 5	10 x 10	15 x 15	20 x 20	25 x 20	25 x 25	50 x 30	50 x 50	75 x 25
0.20	●	●	●	●	●					
0.25	●	●	●	●	●					
0.30	●	●	●	●	●	●	●			
0.40	●	●	●	●	●	●	●			
0.50	●	●	●	●	●	●	●	●	●	
0.75	●	●	●	●	●	●	●	●	●	●
1.00	●	●	●	●	●	●	●	●	●	●
2.00	●	●	●	●	●	●	●	●	●	●
3.00	●	●	●	●	●	●	●	●	●	●
4.00	●	●	●	●	●	●	●	●	●	●
5.00	●	●	●	●	●	●	●	●	●	●
10.00	●	●	●	●	●	●	●	●	●	●
20.00	●	●	●	●	●	●	●	●		

Disks with special electrodes (wrap-around contacts)

Design	OD in mm	TH in mm	Electrodes:
	10 / 16 / 20 / 20 / 25 / 40	0.5 / 1.0 / 2.0	Fired silver (thick film) or PVD (thin film)

Rings



Design	OD in mm	ID in mm	TH in mm	Electrodes:
	10	2.7	0.5 / 1.0 / 2.0	Fired silver (thick film)
	10*	4.3*	0.5 / 1.0 / 2.0	
	10*	5*	0.5 / 1.0 / 2.0	or CuNi (thin film)
	12.7	5.2*	0.5 / 1.0 / 2.0	
	25	16*	0.5 / 1.0 / 2.0	
	38	13*	5.0 / 6.0	
50	19.7*	5.0 / 6.0 / 9.5		

*Tolerances as fired, see table p. 27

Tubes

Design	OD in mm	ID in mm	L in mm	Electrodes:
	76	60	50	Inside:
	40	38	40	Fired silver (thick film)
	20	18	30	Outside:
	10	9	30	Fired silver (thick film)
	10	8	30	or CuNi or Au (thin film)
	6.35	5.35	30	
	3.2	2.2	30	
	2.2	1.0	20	

Tubes with special electrodes

Design	OD in mm	ID in mm	L in mm	Electrodes:
	20	18	30	Inside:
	10	9	30	Fired silver (thick film)
	10	8	30	Outside:
	6.35	5.35	30	Fired silver (thick film) or CuNi or Au (thin film)
	3.2	2.2	30	
	2.2	1.0	30	

Soldering instructions for users

All our metallizations can be soldered in conformance with RoHS. We recommend the use of a solder with the composition Sn 95 / 5 / Ag 3.8 / Cu 0.7. If the piezoceramic element is heated throughout above the Curie temperature, the material is depolarized, and there is thus a loss of, or reduction in, the piezoelectric parameters.

This can be prevented by adhering to the following conditions under all circumstances when soldering:

- All soldered contacts must be point contacts.
- The soldering times must be as short as possible (≤ 3 sec).
- The specific soldering temperature must not be exceeded.

Testing Procedures

STANDARDIZED PROCEDURES PROVIDE CERTAINTY



Comprehensive quality management controls all production process at PI Ceramic, from the quality of the raw materials through to the finished product. This ensures that only released parts that meet the quality specifications go on for further processing and delivery.

Electrical Testing

Small-Signal Measurements

The data for the piezoelectric and dielectric properties such as frequencies, impedances, coupling factors, capacitances and loss factors is determined in small-signal measurements.

Large-Signal Measurements

DC measurements with voltages of up to 1200 V are carried out on actuators to determine the strain, hysteresis and dielectric strength in an automated routine test.

Geometric and Visual Testing Processes

For complex measurements, image processing measurement devices and white-light interferometers for topographical examinations are available.

Visual Limit Values

Ceramic components must conform to certain visual specifications. PI Ceramic has set its own criteria for the quality assessment of the surface finishes, which follow the former MIL-STD-1376. A large variety of applications are taken into account, for special requirements there are graduated

sorting categories. Visual peculiarities must not negatively affect the functioning of the component.

The finish criteria relate to:

- surface finish of the electrode
- pores in the ceramic
- chipping of the edges, scratches, etc.

Quality Level

All tests are carried out in accordance with the DIN ISO 2859 standardized sampling method. The AQL 1.0 level of testing applies for the electrical assessment, for example. A special product specification can be agreed for custom-engineered products. This includes the relevant release records, plots of the measured values or individual measured values of certain test samples through to the testing of each individual piece, for example.

Measurement of Material Data

The data is determined using test pieces with the geometric dimensions laid down in accordance with the EN 50324-2 standard and are typical values (see p. 14 ff). Conformance to these typical parameters is documented by continual testing of the individual material batches before they are released. The characteristics of the individual product can deviate from this and are determined as a function of the geometry, variations in the manufacturing processes and measuring or control conditions.

Integrated Components, Sub-Assemblies

FROM THE CERAMIC TO THE COMPLETE SOLUTION

Ceramics in Different Levels of Integration

PI Ceramic integrates piezo ceramics into the customer's product. This includes both the electrical contacting of the elements according to customer requirements and the mounting of components provided by the customer, i.e. the gluing or the casting of the piezoceramic elements. For the customer, this means an accelerated manufacturing process and shorter lead times.

Sensor Components – Transducers

PI Ceramic supplies complete sound transducers in large batches for a wide variety of application fields. These include OEM assemblies for ultrasonic flow measurement technology, level, force and acceleration measurement.

Piezo Actuators

The simplest form for a piezo actuator is a piezo disk or plate, from which stack actuators with correspondingly higher displacement can be constructed. As an alternative, multilayer actuators are manufactured in different lengths from piezo films with layer thicknesses below 100 µm. Shear actuators consist of stacks of shear plates and are polarized such that they have a displacement perpendicular to the field applied. Bender actuators in different basic forms are constructed with two layers (bimorph) by means of multilayer techno-

logy and thus provide a symmetric displacement.

Piezo actuators can be equipped with sensors to measure the displacement and are then suitable for repeatable positioning with nanometer accuracy. Piezo actuators are often integrated into a mechanical system where lever amplification increases the travel. Flexure guiding systems then provide high stiffness and minimize the lateral offset.

Piezo Motors

Piezo ceramics are the drive element for piezomotors from Physik Instrumente (PI), which make it possible to use the special characteristics of the piezo actuators over longer travel ranges as well.

PILine[®] piezo ultrasonic motors allow for very dynamic placement motions and can be manufactured with such a compact form that they are already being used in many new applications.

Piezo stepping drives provide the high forces which piezo actuators generate over several millimeters. The patented NEXLINE[®] and NEXACT[®] drives from PI with their complex construction from longitudinal, shear and bender elements and the necessary contacting are manufactured completely at PI Ceramic.

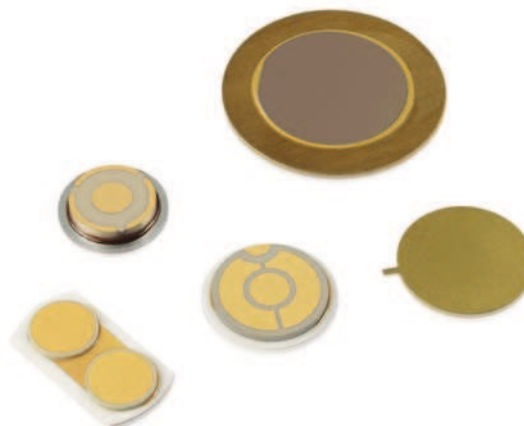
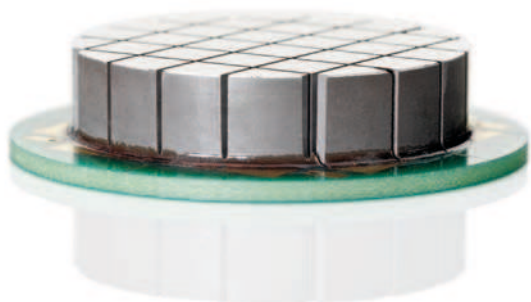
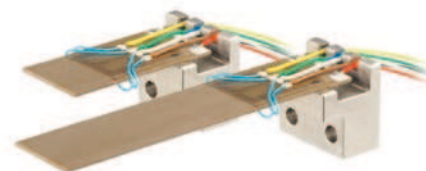

Application Examples for Piezo Ceramic Products

VERSATILE AND FLEXIBLE

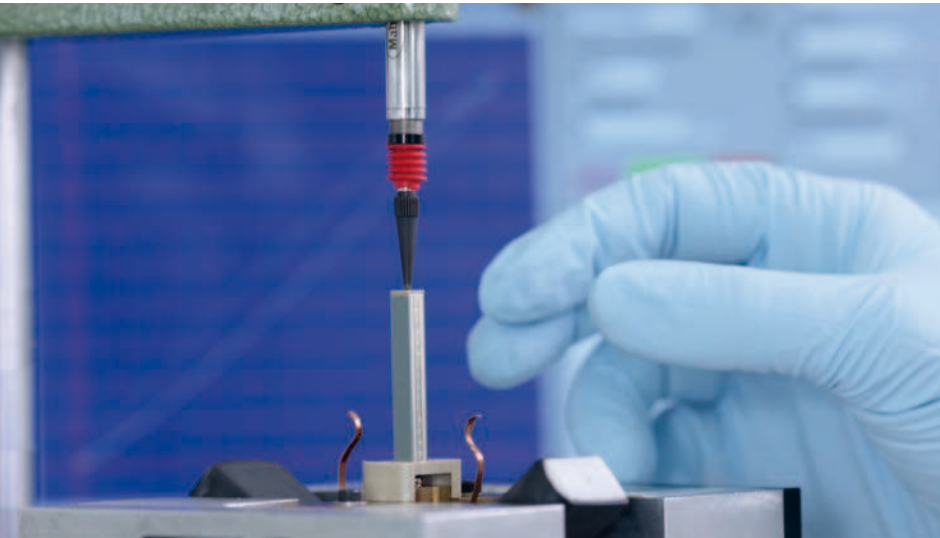

Medical engineering, biotechnology, mechanical engineering or production technology through to semiconductor technology – countless fields benefit from the piezoelectric characteristics of the components. Both the direct and the inverse piezoelectric effect have industrial applications.

Direct Piezoelectric Effect

The piezo element converts mechanical quantities such as pressure, strain or acceleration into a measurable electric voltage.

Mechano-Electrical Transducers

- Sensors for acceleration and pressure
- Vibration pickups, e.g. for the detection of imbalances on rotating machine parts or crash detectors in the automotive field
- Ignition elements
- Piezo keyboards
- Generators, e.g. self-supporting energy sources (energy harvesting)
- Passive damping

Acousto-Electrical Transducers

- Sound and ultrasound receivers, e.g. microphones, level and flow rate measurements
- Noise analysis
- Acoustic Emission Spectroscopy

Inverse Piezoelectric Effect

The piezo element deforms when an electric voltage is applied; mechanical motions or oscillations are generated.

Electro-Mechanical Transducers

Actuators, such as translators, bender elements, piezo motors, for example:

- Micro- and nanopositioning
- Laser Tuning
- Vibration damping
- Micropumps
- Pneumatic valves

Electro-Acoustic Transducers

- Signal generator (buzzer)
- High-voltage sources / transformers
- Delay lines
- High-powered ultrasonic generators: Cleaning, welding, atomization, etc.

Ultrasonic signal processing uses both effects and evaluates propagation times, reflection and phase shift of ultrasonic waves in a frequency band from a few hertz right up to several megahertz.

Applications are e.g.

- Level measurement
- Flow rate measurement
- Object recognition and monitoring
- Medical diagnostics
- High-resolution materials testing
- Sonar and echo sounders
- Adaptive structures

Pumping and Dosing Techniques with Piezo Drives

Increasing miniaturization places continuously higher demands on the components used, and thus on the drives for microdosing systems as well. Piezoelectric elements provide the solution here: They are reliable, fast and precise in operation and can be shaped to fit into the smallest installation space. At the same time their energy consumption is low, and they are small and low-cost. The dosing quantities range from milliliter, microliter, nanoliter right down to the picoliter range.

The fields of application for piezoelectric pumps are in laboratory technology and medical engineering, biotechnology, chemical analysis and process engineering which frequently require reliable dosing of minute amounts of liquids and gases.

Micro-Diaphragm Pumps, Microdosing Valves

The drive for the pump consists of a piezo-electric actuator connected to a pump diaphragm, usually made of metal or silicon. The deformation of the piezo element changes the volume in the pump chamber, the drive being separated from the medium to be pumped by the diaphragm. Depending on the drop size and the diaphragm lift thus required, and also the viscosity of the medium, they can be driven directly with piezo disks, piezo stack actuators or by means of levered systems.

Their compact dimensions also make these dosing devices suitable for lab-on-a-chip applications.

Piezo drives are also used for opening and closing valves. The range here is from a simple piezo element or bender actuator for a diaphragm valve, preloaded piezo stack actuators for large dynamics and force through to piezo levers which carry out fine dosing even at high backpressure.

In the automotive industry, fuel injection systems driven by multilayer stack actuators are also microdosing valves.

Peristaltic Pumps, Jet Dispensers

So-called peristaltic pumps are ideal in cases where liquids or gases are to be dosed accurately and also as evenly and with as little pulsing as possible. The external mechanical deformation of the tube forces the medium to be transported through this tube. The pumping direction is determined by the control of the individual actuators.

The drive element consists of flat piezo bender elements, compact piezo chip actuators or piezo stack actuators, depending on the power and size requirements. Bender actuators are suitable mainly for applications with low backpressure, e.g. for liquids with low viscosity.

Piezo actuators are better able to cope with higher backpressure and are suitable for dosing substances with higher viscosity, but require more space.

Piezoelectric Microdispensers, Drop-on-Demand

Piezoelectric microdispensers consist of a liquid-filled capillary which is shaped into a nozzle and a surrounding piezo tube.

When a voltage is applied, the piezo tube contracts and generates a pressure wave in the capillary. This means that individual drops are pinched off and accelerated to a velocity of a few meters per second so that they can travel over several centimeters.

The volume of the drop varies with the properties of the medium transported, the dimensions of the pump capillaries and the control parameters of the piezo actuator. Micro-channels etched into silicon can also be used as nozzles.

Ultrasound Applications in Medical Engineering

The piezoelectric effect is used for a large number of applications in the life sciences: For example, for imaging in medical diagnostics, in therapy for the treatment of pain, for aerosol generation or the removal of tartar from teeth, for scalpels in eye surgery, for monitoring liquids, such as in the detection of air bubbles in dialysis, or also as a drive for dispensers and micro-pumps .

If high power densities are required, as is the case with ultrasonic tartar removal or for surgical instruments, for example, “hard” PZT materials are used .

Ultrasonic Instruments in Surgical and Cosmetic Applications

Nowadays, instruments with ultrasonic drives allow minimally invasive surgical techniques in eye and oral surgery, for example . Devices for liposuction are also often based on ultrasonic technology . Piezo elements have long been used as ultrasonic generators to remove mineral deposits on human teeth .

The principle is always similar and works just like ultrasonic material machining: Piezoceramic composite systems made of ring disks clamped together are integrated in a sonotrode in the form of a medical instrument . This transmits vibration amplitudes in the μm range at operating frequencies of around 40 kHz .

Ultrasound Imaging – Sonography

The big advantage of sonography is the harmlessness of the sound waves, which is why the method is widely used . The ultrasonic transmitter contains a piezo element, which generates ultrasonic waves and also detects them again . The ultrasonic transmitter emits short, directional sound wave pulses which are reflected and scattered by the tissue layers to different degrees . By measuring the propagation time and the magnitude of the reflection an image of the structure under investigation is produced .



Instruments for the removal of tartar with ultrasound, OEM product . The piezo disks can be clearly seen .

Ultrasound Therapy

This method involves irradiating the tissue with ultrasonic waves by means of an ultrasonic transmitter. On the one hand, mechanical, longitudinal waves generate vibrations in the tissue, on the other, they convert part of the ultrasonic energy into heat.

Typical working frequencies are in the range 0.8 to over 3 MHz, both continuous wave and pulsed wave ultrasonic techniques being used in the application. The vibration amplitudes transmitted are in the range around 1 μm .

Different effects are achieved depending on the energy of the radiation. High-energy shock waves are used to destroy kidney stones, for example. Low-energy shock waves effect a type of micro-massage, and are used for the treatment of bones and tissue and in physiotherapy among other things.

In cosmetic applications ultrasonophoresis, i.e. the introduction of drugs into the skin, is becoming increasingly important.

Aerosol Production

Ultrasound makes it possible to nebulize liquids without increasing the pressure or the temperature, a fact which is of crucial importance particularly for sensitive substances such as medicines.

The process is similar to high-frequency ultrasonic cleaning – a piezoceramic disk fixed in the liquid container and oscillating in resonance generates high-intensity ultrasonic waves. The drops of liquid are created near the surface by capillary waves.

The diameter of the aerosol droplets is determined by the frequency of the ultrasonic waves: The higher the frequency, the smaller the droplets.

For direct atomization, where the piezo element oscillating at high frequency is in direct contact with the liquid, the piezo surface is specially treated against aggressive substances.

Ultrasonic Sensors: Piezo Elements in Metrology

Flow Rate Measurement

In many areas the measurement of flow rates is the basis for processes operating in a controlled way. In modern building services, for example, the consumption of water, hot water or heating energy is recorded and the supply as well as the billing is thus controlled.

In industrial automation and especially in the chemical industry, volume measurement can replace the weighing of substance quantities.

Not only the flow velocity, but also the concentration of certain substances can be detected.

The measurement of the propagation time

is based on the transmitting and receiving of ultrasonic pulses on alternating sides in the direction of flow and in the opposite direction. Here, two piezo transducers operating as both transmitter and receiver are arranged in a sound section diagonally to the direction of flow.

The **Doppler effect** is used to evaluate the phase and frequency shift of the ultrasonic waves which are scattered or reflected by particles of liquid. The frequency shift between the emitted wave front and the reflected wave front received by the same piezo transducer is a measure of the flow velocity.

Ultrasonic Sensors: Piezo Elements in Metrology

Level Measurement

For **propagation time measurements** the piezo transducer operates outside the medium to be measured as both transmitter and receiver. It emits an ultrasonic pulse in air which is reflected by the content. The propagation time required is a measure of the distance travelled in the empty part of the container.

This allows non-contact measurements whereby the level of liquids, and also solids, in silos for example, can be measured.

The resolution or accuracy depends on how well the ultrasonic pulse is reflected by the respective surface.

Submersible transducers, or tuning fork sensors, are almost exclusively used as level switches; several of these sensors at different heights are required to measure the level. The piezo transducer excites a tuning fork at its natural frequency. When in contact with the medium to be measured, the resonance frequency shifts and this is evaluated electronically. This method works reliably and suffers hardly any breakdowns. Moreover, it is independent of the type of material to be filled.

Detection of Particles and Air Bubbles

The ultrasonic bubble sensor provides a reliable control of liquid transport in tubes. The sensor undertakes non-contact detection of the air and gas bubbles in the liquid through the tube wall, and thus allows continuous quality monitoring.

The application possibilities are in the medical, pharmaceutical and food technology fields. The sensors are used to monitor dialysis machines, infusion pumps or transfusions. Industrial applications include control technology, such as the monitoring of dosing and filling machines, for example.

Acceleration and Force Sensors, Force Transducer

The key component of the piezoelectric acceleration sensor is a disk of piezoelectric ceramic which is connected to a seismic mass. If the complete system is accelerated, this mass increases the mechanical deformation of the piezo disk, and thus increases the measurable voltage. The sensors detect accelerations in a broad range of frequencies and dynamics with an almost linear characteristic over the complete measurement range.

Piezoelectric force sensors are suitable for the measurement of dynamic tensile, compression and shearing forces. They can be designed with very high stiffness and can also measure high-dynamic forces. A very high resolution is typical.



Example of a tuning fork for level measurement, OEM product

Piezoelectric Actuators

Piezoelectric translators are ceramic solid state actuators which convert electrical energy directly into linear motion with theoretically unlimited resolution. The length of the actuator changes by up to 0.15 % in this process. The actuators simultaneously generate large static and dynamic forces.

Their special characteristics mean that piezo actuators are ideal for semiconductor, optical and telecommunications applications. They are also used in the automotive field, in pneumatic valve technology and vibration damping, and for micropumps.

PI Ceramic provides not only hundreds of standard versions but also special customized versions quickly and reliably. The actuators can be equipped with position sensors for applications requiring high closed-loop linearity of motion.

Piezo Systems with High Force Generation: PICA

So-called high-voltage piezo actuators are manufactured from piezoceramic disks in a stack construction. The individual layers are produced by pressing technology. Applications for the high-load actuators can be found in mechanical engineering for out-of-round rotations, for example, in active vibration control or for switching applications.

Many modifications are possible:

- Customized materials
- Layer thickness and thus voltage range
- Dimensions and basic form
- Force ranges resp. custom load
- Design and material of end pieces
- Extra-tight length tolerances
- Integrated piezoelectric sensor disks
- Special high / low temperature versions
- Vacuum-compatible and non-magnetic versions

Piezo Actuators from PI Ceramic

- Motion with sub-nanometer resolution
- High forces (up to over 50,000 N), high load capacity (up to 100 MPa)
- Microsecond response
- Free of play and friction
- Minimum power consumption when maintaining its position
- Non-wearing
- High reliability (> 10⁹ switching cycles)
- Suitable for vacuum use and cleanrooms
- Can operate at cryogenic temperatures
- Magnetic fields have no influence and are themselves not influenced



Choice of piezo stack actuators

Piezoelectric Actuators

Reliable Piezo Actuators with Low Operating Voltage: PICMA®

PICMA® multilayer actuators are constructed using tape technology and are subsequently sintered in the multilayer co-firing process. The special PICMA® PZT ceramic and its manufacturing technique produce an ideal combination of stiffness, capacitance, displacement, temperature stability and lifetime. The typical operating voltage of the PICMA® multilayer actuators is 100 to 120 V.

PICMA® piezo actuators are the only multilayer actuators in the world with ceramic encapsulation. This technology protects the PICMA® actuators from environmental influences, in particular humidity, and ensures their extremely high reliability and performance even under harsh industrial operating conditions. The lifetime of PICMA® actuators is significantly better than that of piezo actuators with conventional polymer encapsulation.

Since PICMA® piezo actuators do not require additional polymer insulation and can be operated up to 150 °C they are ideal for use in high vacuum. They even work, at a reduced travel, in the cryogenic temperature range.

Many fields of application benefit from this reliability: Precision engineering and

precision machining as well as switches and pneumatic or hydraulic valves. Further applications can be found in the fields of active vibration control, nanotechnology, metrology, optics and interferometry.

Preloaded Actuators – Levers – Nanopositioning

PICMA® piezo actuators from PI Ceramic are the key component for nanopositioning systems from Physik Instrumente (PI). They are supplied in different levels of integration: As simple actuators with position sensor as an optional extra, encased with or without preload, with lever amplification for increased travel, right through to high-performance nanopositioning systems where piezo actuators drive up to six axes by means of zero-wear and frictionless flexure guidings.

What they all have in common is a motion resolution in the nanometer range, long lifetimes and outstanding reliability. The combination of PICMA® actuators, flexure guiding and precision measurement systems produces nanopositioning devices in the highest performance class.

The fields of application range from semiconductor technology, metrology, microscopy, photonics through to biotechnology, aerospace, astronomy and cryogenic environments.

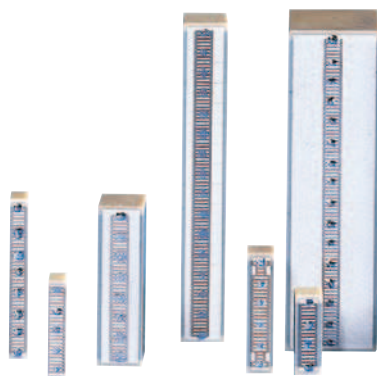

Piezoelectric PICMA® actuators



Lever amplified system

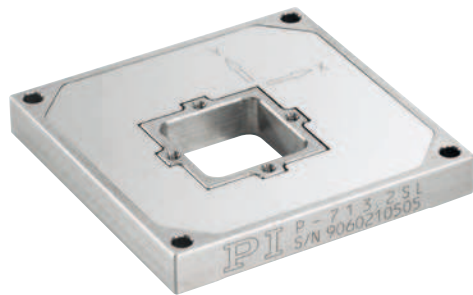

Piezo nanopositioning system with parallel kinematics and displacement sensors

Vibration Control

If a mechanical system is knocked off balance, this can result in vibrations which adversely affect plants, machines and sensitive devices and thus affect the quality of the products. In many applications it is not possible to wait until environmental influences dampen the vibration and bring it to a halt; moreover, several interferences usually overlap in time, resulting in a quite confusing vibration spectrum with a variety of frequencies.

The vibrations must therefore be insulated in order to dynamically decouple the object from its surroundings and thus reduce the transmission of shocks and solid-borne sound. This increases the precision of measuring or production processes and the settling times reduce significantly, which means higher throughputs are possible. Piezoelectric components can dampen vibrations particularly in the lower frequency range, either actively or passively.

Passive Vibration Insulation

Elastic materials absorb the vibrations and reduce them. Piezo elements can also be used for this: They absorb the mechanical energy of the structural vibrations and convert it into electrical energy at the same time. This is subsequently converted into heat by means of parallel electrical resistors, for example.

Passive elements are installed as close to the object to be decoupled as possible.

The conventional passive methods of vibration insulation are no longer sufficient for many of today's technologies. Movements

and jolts caused by footfall, fans, cooling systems, motors, machining processes etc. can distort patterns e.g. when micromachining to such an extent that the result is unusable.

Active Vibration Insulation

In this process, counter-motions compensate or minimize the interfering vibrations, and they do this as close to the source as possible. To this end a suitable servo loop must initially detect the structural vibrations before the counter-motions are actively generated.

Adaptive materials, such as piezoceramic plates or disks, can act as both sensors and actuators. The frequency range and the mass to be damped determine the choice of suitable piezo actuators. This also requires an external voltage source and suitable control electronics.

Multilayer ceramic construction produces increased efficiency. Multilayer piezoelectric actuators, such as the PICMA multilayer translators, for example, can be used anywhere where precisely dosed alternating forces are to act on structures.

The main application fields are in aeronautics and aerospace, where fuel must be saved, for example, or the oscillations of lattice constructions for antennas are to be damped. One of the objectives when building vehicles and ships is to minimize noise in the interior. In mechanical engineering for example, the vibrations of rotating drives are increasingly being insulated and actively suppressed.



Adaptive Systems, Smart Structures

Industrial Applications of the Future

The development of adaptive systems is increasing in significance for modern industry. Intelligent materials are becoming more and more important here, so-called "smart materials" which possess both sensor and actuator characteristics. They detect

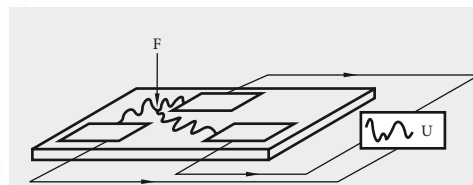

A deformation of the substrate gives rise to an electrical signal. The DuraAct transducer can therefore detect deformations with precision and high dynamics.

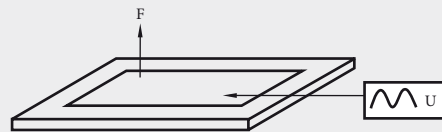

The DuraAct patch transducer contracts when a voltage is applied. Attached to a substrate it acts as a bender element in this case.

changed environmental conditions such as impact, pressure or bending loads and react to them.

Piezo ceramics belong to this group of adaptive materials. The piezoelectric DuraAct patch transducers provide a compact solution. They are based on a thin piezoceramic film which is covered with electrically conducting material to make the electrical contact and are subsequently embedded in an elastic polymer composite. The piezoceramic element, which is brittle in itself, is thus mechanically preloaded and electrically insulated and is so robust that it can even be applied to curved surfaces with bending radii of only a few millimeters.

The transducers are simply glued to the corresponding substrate or already integrated into a structure during manufacture, where they detect or generate vibrations or contour deformations in the component itself. The size of the contour change here is strongly dependent on the substrate properties and ranges from the nanometer up into the millimeter range.

Even under high dynamic load the construction guarantees high damage tolerance, reliability and a lifetime of more than 10^9 cycles. They have low susceptibility to wear and defects because the transducers are solid state actuators and thus do not contain any moving parts.

Energy from Vibration – Energy Harvesting

To dispense with the need for batteries and the associated servicing work, it is possible to use energy from the surrounding environment. Piezo elements convert kinetic energy from oscillations or shocks into electrical energy.

The robust and compact DuraAct transducers can also be used here. Deformations

of the substrate cause a deformation of the DuraAct patch transducer and thus generate an electrical signal. Suitable transducer and storage electronics can thus provide a decentralized supply for monitoring systems installed at locations which are difficult to access.

Ultrasonic Machining of Materials

Ultrasonic applications for the machining of materials are characterized mainly by their high power density. The applications typically take place in resonance mode in order to achieve maximum mechanical power at small excitation amplitude.

The ferroelectric “hard” PZT materials are particularly suitable for these high-power ultrasonic machining applications. They exhibit only low dielectric losses even in continuous operation, and thus consequently only low intrinsic warming.

Their typical piezoelectric characteristics are particularly important for the high mechanical loads and operating field strengths: Moderate permittivity, large piezoelectric coupling factors, high mechanical quality factors and very good stability.

Ultrasound for Bonding: Joining Techniques

Ultrasonic bonding processes can be used to bond various materials such as thermoplastics, and metallic materials like aluminum

and copper and their alloys. This principle is used by wire bonders in the semiconductor industry and ultrasonic welding systems, for example.

The ultrasonic energy is generated primarily via mechanically strained piezo ring disks, amplified by means of a so-called sonotrode and applied to the bond. The friction of the bonding partners then generates the heat required to fuse, or weld, the materials together around the bond.

Shaping by Machining

Apart from the welding processes, the ultrasonic processing of hard mineral or crystalline materials such as ceramic, graphite or glass, especially by ultrasonic drilling or machining, like vibration lapping, is increasingly gaining in importance.

This makes it possible to produce geometrically complex shapes and three-dimensional contours, with only a small contact pressure being required. Specially shaped sonotrodes are also used here as the machining tool.

Sonar Technology and Hydroacoustics

Sonar technology systems (sonar = sound navigation and ranging) and hydroacoustic systems are used for measuring and position-finding tasks especially in maritime applications. The development of high-resolution sonar systems, which was driven by military applications, is now increasingly being replaced by civil applications.

Apart from still used submarine positioning

sonars, systems are used for depth measurements, for locating shoals of fish, for subsurface relief surveying in shallow waters, underwater communication, etc.

A diverse range of piezo components is used, ranging from the simple disk or plate and stacked transducers through to sonar arrays which make it possible to achieve a linear deflection of the directivity pattern of the ultrasonic wave.



The PI Group Milestones

A SUCCESS STORY



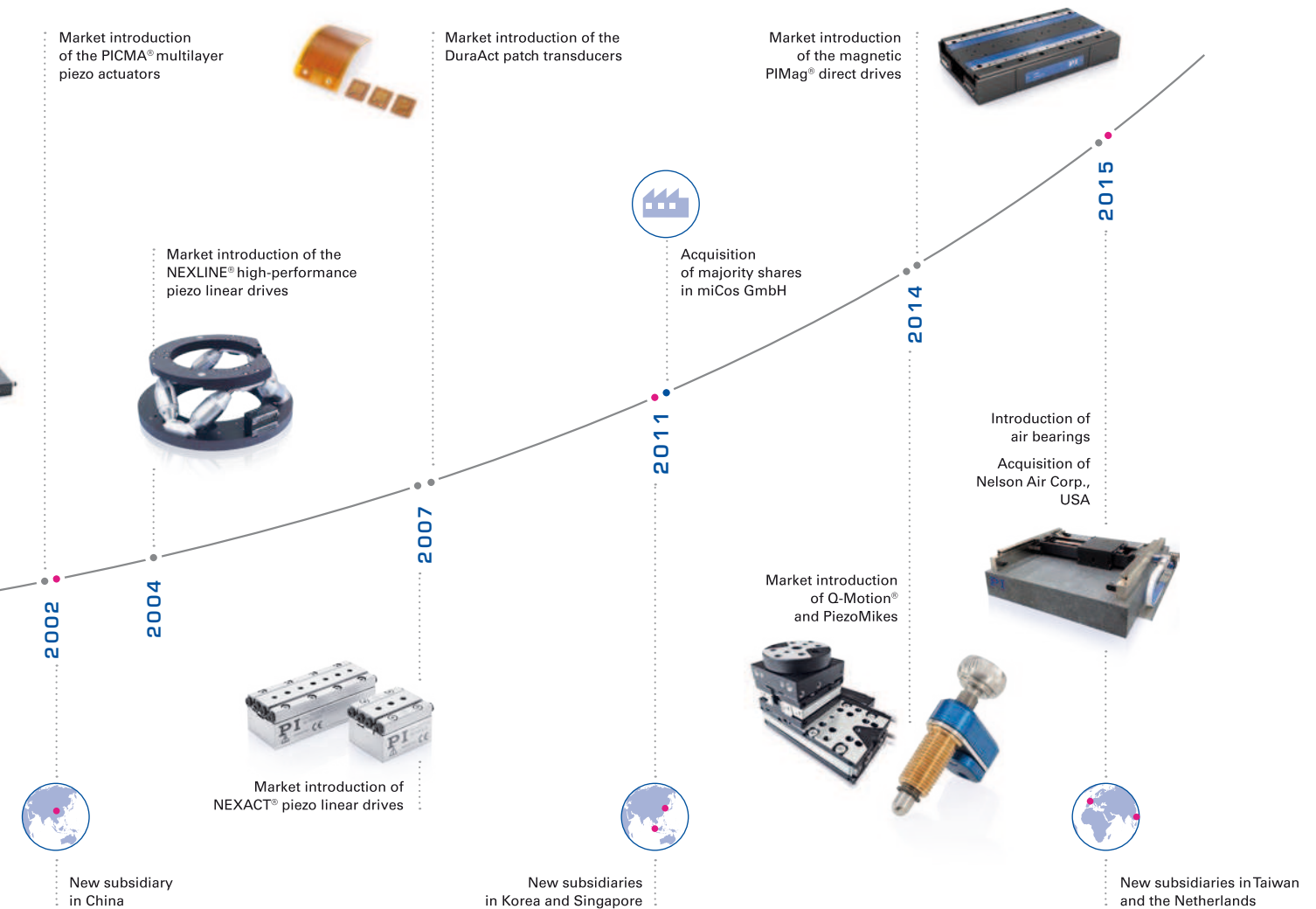



Headquarters

GERMANY

PI Ceramic GmbH
Lindenstrasse
Lederhose
Phone +49 36604 882-0
Fax +49 36604 882-4109
info@piceramic.com
www.piceramic.com

Physik Instrumente (PI) GmbH & Co. KG
Auf der Roemerstrasse 1
76228 Karlsruhe
Phone +49 721 4846-0
Fax +49 721 4846-1019
info@pi.ws
www.pi.ws

PI miCos GmbH
Freiburger Strasse 30
Eschbach
Phone +49 7634 5057-0
Fax +49 7634 5057-99
info@pimicos.com
www.pi.ws



Visit us on
youtube!



© Physik Instrumente (PI) GmbH & Co. KG

All contents, including texts, graphics, data etc., as well as their layout, are subject to copyright and other protective laws. Any copying, modification or redistribution in whole or in parts is subject to a written permission of PI.

Although the information in this document has been compiled with the greatest care, errors cannot be ruled out completely. Therefore, we cannot guarantee for the information being complete, correct and up to date. Illustrations may differ from the original and are not binding. PI reserves the right to supplement or change the information provided without prior notice.

Subsidiaries

USA (East) & CANADA

PI (Physik Instrumente) L.P.
Auburn, MA 01501
www.pi-usa.us

USA (San Francisco Bay Area Office)

PI (Physik Instrumente) L.P.
Sausalito, CA 94965
www.pi-usa.us

ITALY

Physik Instrumente (PI) S. r. l.
Bresso
www.pionline.it

FRANCE

PI France SAS
Aix-en-Provence
www.pi.ws

JAPAN

PI Japan Co., Ltd.
Tokyo
www.pi-japan.jp

CHINA

Physik Instrumente (PI Shanghai) Co., Ltd.
Shanghai
www.pi-china.cn

SOUTHEAST ASIA

PI (Physik Instrumente) Singapore LLP
Singapore
www.pi-singapore.sg
For ID / MY / PH / SG / TH / VNM

KOREA

PI Korea Ltd.
Seoul
www.pikorea.co.kr

USA (West) & MEXIKO

PI (Physik Instrumente) L.P.
Irvine, CA 92620
www.pi-usa.us

UK & IRELAND

PI (Physik Instrumente) Ltd.
Cranfield, Bedford
www.physikinstrumente.co.uk

NETHERLANDS

PI Benelux B.V.
Sint-Oedenrode
www.pi.ws

SPAIN

Micos Iberia S.L.
Vilanova i la Geltrú
www.pimicos.es

PI Japan Co., Ltd.
Osaka
www.pi-japan.jp

Physik Instrumente (PI Shanghai) Co., Ltd.
Beijing
www.pi-china.cn

TAIWAN

Physik Instrumente (PI) Taiwan Ltd.
Taipei
www.pi-taiwan.com.tw